

# JVC

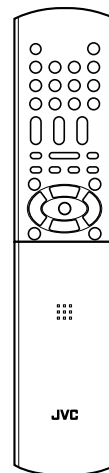

## HOME CINEMA CONTROL CENTER

# RX-E5S/RX-E51B

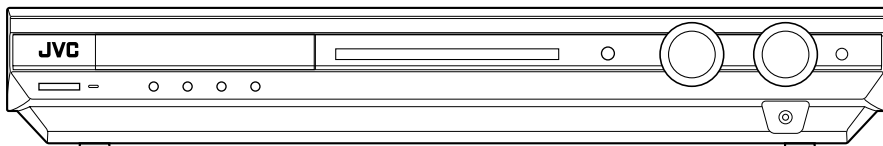

# INSTRUCTIONS

# Warnings, Cautions and Others

## **IMPORTANT for the U.K.**

**DO NOT** cut off the mains plug from this equipment. If the plug fitted is not suitable for the power points in your home or the cable is too short to reach a power point, then obtain an appropriate safety approved extension lead or consult your dealer.

**BE SURE** to replace the fuse only with an identical approved type, as originally fitted.

If nonetheless the mains plug is cut off ensure to remove the fuse and dispose of the plug immediately, to avoid a possible shock hazard by inadvertent connection to the mains supply.

If this product is not supplied fitted with a mains plug then follow the instructions given below:

## **IMPORTANT:**

**DO NOT** make any connection to the terminal which is marked with the letter E or by the safety earth symbol or coloured green or green-and-yellow.

The wires in the mains lead on this product are coloured in accordance with the following code:

Blue : Neutral  
Brown : Live

As these colours may not correspond with the coloured markings identifying the terminals in your plug proceed as follows:

The wire which is coloured blue must be connected to the terminal which is marked with the letter N or coloured black.

The wire which is coloured brown must be connected to the terminal which is marked with the letter L or coloured red.

**IF IN DOUBT - CONSULT A COMPETENT ELECTRICIAN.**

## **Caution—/I STANDBY/ON button!**

Disconnect the mains plug to shut the power off completely. The /I STANDBY/ON button in any position does not disconnect the mains line. The power can be remote controlled.

## **CAUTION**

To reduce the risk of electrical shocks, fire, etc.:

1. Do not remove screws, covers or cabinet.
2. Do not expose this appliance to rain or moisture.

## **CAUTION**

- Do not block the ventilation openings or holes. (If the ventilation openings or holes are blocked by a newspaper or cloth, etc., the heat may not be able to get out.)
- Do not place any naked flame sources, such as lighted candles, on the apparatus.
- When discarding batteries, environmental problems must be considered and local rules or laws governing the disposal of these batteries must be followed strictly.
- Do not expose this apparatus to rain, moisture, dripping or splashing and that no objects filled with liquids such as vases, shall be placed on the apparatus.

---

**Caution: Proper Ventilation**

To avoid risk of electric shock and fire and to protect from damage.

Locate the apparatus as follows:

Front: No obstructions open spacing.

Sides: No obstructions in 10 cm from the sides.

Back: No obstructions in 15 cm from the back.

Bottom: No obstructions, place on the level surface.

In addition, maintain the best possible air circulation as illustrated.

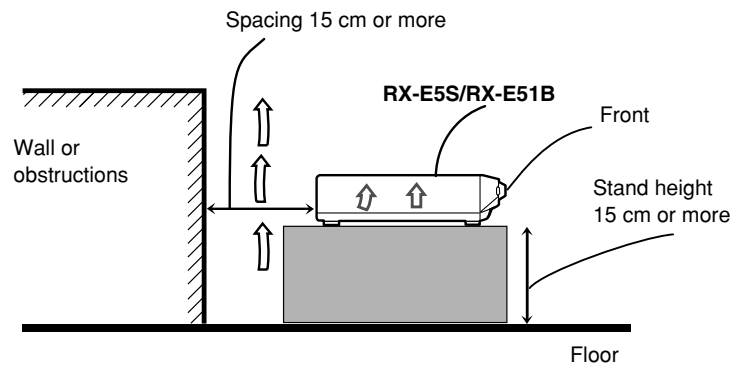

## **SAFETY INSTRUCTIONS**

### **“SOME DOS AND DON'TS ON THE SAFE USE OF EQUIPMENT”**

This equipment has been designed and manufactured to meet international safety standards but, like any electrical equipment, care must be taken if you are to obtain the best results and safety is to be assured.

\*\*\*\*\*

Do read the operating instructions before you attempt to use the equipment.

Do ensure that all electrical connections (including the mains plug, extension leads and interconnections between pieces of equipment) are properly made and in accordance with the manufacturer's instructions. Switch off and withdraw the mains plug when making or changing connections.

Do consult your dealer if you are ever in doubt about the installation, operation or safety of your equipment.

Do be careful with glass panels or doors on equipment.

\*\*\*\*\*

DON'T continue to operate the equipment if you are in any doubt about it working normally, or if it is damaged in any way—switch off, withdraw the mains plug and consult your dealer.

DON'T remove any fixed cover as this may expose dangerous voltages.

DON'T leave equipment switched on when it is unattended unless it is specifically stated that it is designed for unattended operation or has a standby mode.

Switch off using the switch on the equipment and make sure that your family know how to do this. Special arrangements may need to be made for infirm or handicapped people.

DON'T use equipment such as personal stereos or radios so that you are distracted from the requirements of traffic safety. It is illegal to watch television whilst driving.

DON'T listen to headphones at high volume as such use can permanently damage your hearing.

DON'T obstruct the ventilation of the equipment, for example with curtains or soft furnishings.

Overheating will cause damage and shorten the life of the equipment.

DON'T use makeshift stands and NEVER fix legs with wood screws—to ensure complete safety always fit the manufacturer's approved stand or legs with the fixings provided according to the instructions.

DON'T allow electrical equipment to be exposed to rain or moisture.

ABOVE ALL

- NEVER let anyone, especially children, push anything into holes, slots or any other opening in the case—this could result in a fatal electrical shock.;
- NEVER guess or take chances with electrical equipment of any kind—it is better to be safe than sorry!

# Table of Contents

---

<b>Parts identification .....</b>	<b>2</b>
<b>Getting started .....</b>	<b>4</b>
Before Installation .....	4
Checking the supplied accessories .....	4
Putting batteries in the remote control .....	4
Connecting the FM and AM (MW) antennas .....	5
Connecting the speakers .....	6
Connecting video components .....	7
Connecting the power cord .....	9
<b>Basic operations .....</b>	<b>10</b>
1 Turn on the power .....	10
2 Select the source to play .....	10
3 Adjust the volume .....	11
Selecting the digital decode mode .....	11
Adjusting the subwoofer audio position .....	12
Activating TV Direct .....	12
Turning off the sounds temporarily .....	13
Changing the display brightness .....	13
Turning off the power with the Sleep Timer .....	13
<b>Basic settings .....</b>	<b>14</b>
Setting the speaker information automatically —Smart Surround Setup .....	14
Basic setting items .....	15
Operating procedure .....	16
Setting the speakers .....	16
Setting bass sound .....	17
Setting the virtual surround back speaker—VIRTUAL SB ...	18
Selecting the main or sub channel—DUAL MONO .....	18
Using the Midnight mode—MIDNIGHT M. ....	18
Setting the digital input (DIGITAL IN) terminals —DIGITAL IN1/2 .....	19
Setting Auto Surround—AUTO SURRND .....	19
Setting the Auto Function mode—AUTO MODE .....	19
<b>Sound adjustments .....</b>	<b>20</b>
Basic adjustment items .....	20
Operating procedure .....	20
Adjusting speaker output level .....	21
Adjusting the sound parameters for the Surround/DSP modes .....	21
Adjusting the bass sounds .....	22
Adjusting the equalization patterns —D EQ 63Hz/250Hz/1kHz/4kHz/16kHz .....	22
<b>Tuner operations .....</b>	<b>23</b>
Tuning in to stations manually .....	23
Using preset tuning .....	23
Selecting the FM reception mode .....	24
Using the Radio Data System (RDS) to receive FM stations .....	25
Searching for a program by PTY codes .....	26
Switching to broadcast program of your choice temporarily .....	28
<b>Creating realistic sound fields .....</b>	<b>29</b>
Reproducing theatre ambience .....	29
Introducing the Surround modes .....	29
Introducing the DSP modes .....	31
Using the Surround/DSP modes .....	32
<b>Operating other JVC products .....</b>	<b>34</b>
<b>Operating other manufacturers' products .....</b>	<b>36</b>
<b>Troubleshooting .....</b>	<b>39</b>
<b>Specifications .....</b>	<b>40</b>

# Parts identification

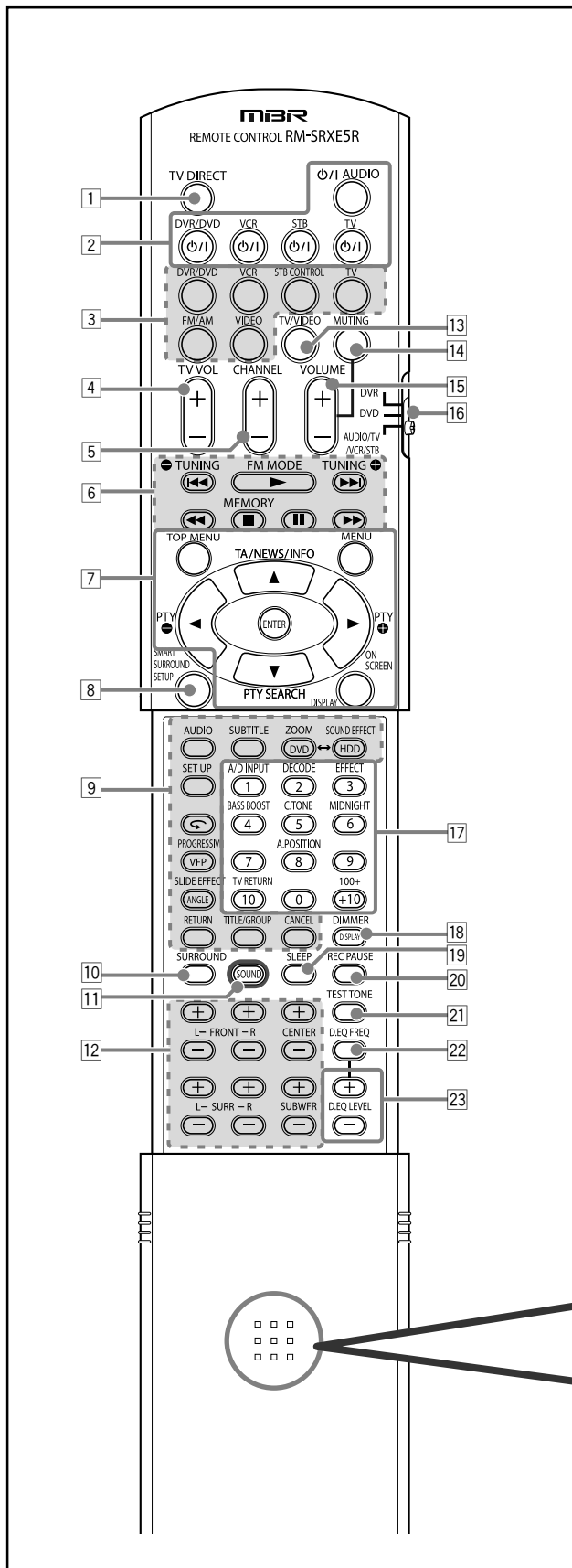

## Remote control

See pages in parentheses for details.

- 1 TV DIRECT button (12)
- 2 Standby/on buttons (10, 34 – 38)  
 $\phi$ /I AUDIO, DVR/DVD  $\phi$ /I, VCR  $\phi$ /I, STB  $\phi$ /I, TV  $\phi$ /I
- 3 • Source selecting buttons (10, 12, 23, 34, 36, 37)  
 DVR/DVD, VCR, TV, FM/AM, VIDEO  
 • STB CONTROL button (38)
- 4 TV VOL (volume) +/- button (34, 36)
- 5 CHANNEL +/- button (34 – 38)
- 6 • Operating buttons for video components (34, 35, 37)  
 $\lll$ ,  $\ggg$ ,  $\lll$ ,  $\ggg$ ,  $\blacksquare$ ,  $\parallel$ ,  $\ggg$   
 • Operating buttons for tuner (23, 24)  
 $\ominus$  TUNING, FM MODE, TUNING  $\oplus$ , MEMORY
- 7 • Operating buttons for DVD recorder or DVD player\* (35)  
 TOP MENU, MENU, cursor buttons ( $\blacktriangleright$ ,  $\blacktriangleleft$ ,  $\blacktriangleup$ ,  $\blacktriangledown$ ), ENTER, ON SCREEN  
 • Operating buttons for RDS (25, 26, 28)  
 PTY  $\oplus$ , PTY  $\ominus$ , TA/NEWS/INFO, PTY SEARCH, DISPLAY
- 8 SMART SURROUND SETUP button (14)
- 9 Operating buttons for DVD recorder or DVD player\* (35)  
 AUDIO, SUBTITLE, DVD, ZOOM, HDD, SOUND EFFECT, SET UP,  $\curvearrowright$ , VFP, PROGRESSIVE, ANGLE, SLIDE EFFECT, RETURN, TITLE/GROUP, CANCEL
- 10 SURROUND button (32)
- 11 SOUND button (10 – 12, 18, 21, 22)
- 12 Adjusting buttons for speaker and subwoofer output levels (21)  
 FRONT L +/-, FRONT R +/-, CENTER +/-, SURR L +/-, SURR R +/-, SUBWFR +/-
- 13 TV/VIDEO button (34, 36)
- 14 MUTING button (13)
- 15 VOLUME +/- button (11)
- 16 Mode selector (10, 34 – 37)  
 DVR, DVD, AUDIO/TV/VCR/STB
- 17 • Numeric buttons (24, 34 – 38)  
 • Adjusting buttons (10 – 12, 18, 21, 22)  
 A/D INPUT, DECODE, EFFECT, BASS BOOST, C.TONE, MIDNIGHT, A.POSITION  
 • TV RETURN button (34)
- 18 • DISPLAY button\* (35)
- 19 DIMMER button (13, 35)
- 20 SLEEP button (13)
- 21 REC PAUSE button (35)
- 22 TEST TONE button (21)
- 23 D.EQ FREQ button (22)
- 24 D.EQ LEVEL +/- buttons (22)

\* These buttons can be used for operating a JVC DVD recorder or DVD player with the mode selector set to "DVR" or "DVD" (see page 35).

If these buttons do not function normally, use the remote control supplied with your DVD recorder or DVD player. Refer also to the manuals supplied with the DVD recorder or DVD player for details.

To open the cover of the remote control, push here then slide downward.

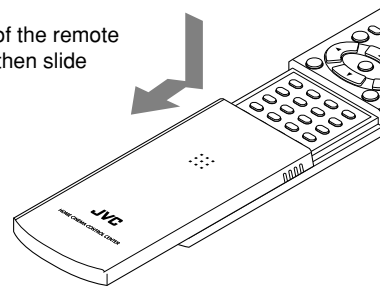

See pages in parentheses for details.

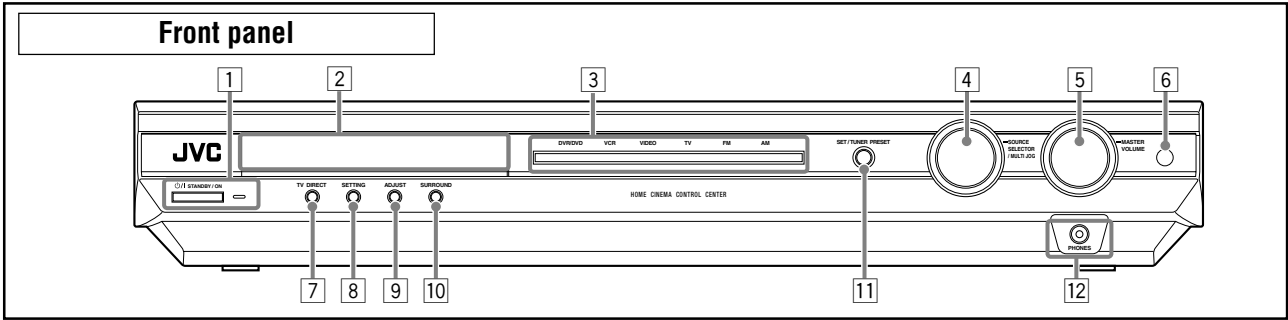

- |   |  |    |   |
|---|--|----|---|
| 1 | ⏻/STANDBY/ON button and standby lamp (10)                  | 7  | TV DIRECT button (12)                               |
| 2 | Display window (see below)                                 | 8  | SETTING button (16)                                 |
| 3 | Source lamps<br>DVR/DVD, VCR, VIDEO, TV, FM, AM            | 9  | ADJUST button (20)                                  |
| 4 | • SOURCE SELECTOR (10, 24)<br>• MULTI JOG (16, 20, 24, 33) | 10 | SURROUND button (33)                                |
| 5 | MASTER VOLUME control (11)                                 | 11 | • SET button (16, 20)<br>• TUNER PRESET button (24) |
| 6 | Remote sensor (4)  | 12 | PHONES jack (11)                                    |

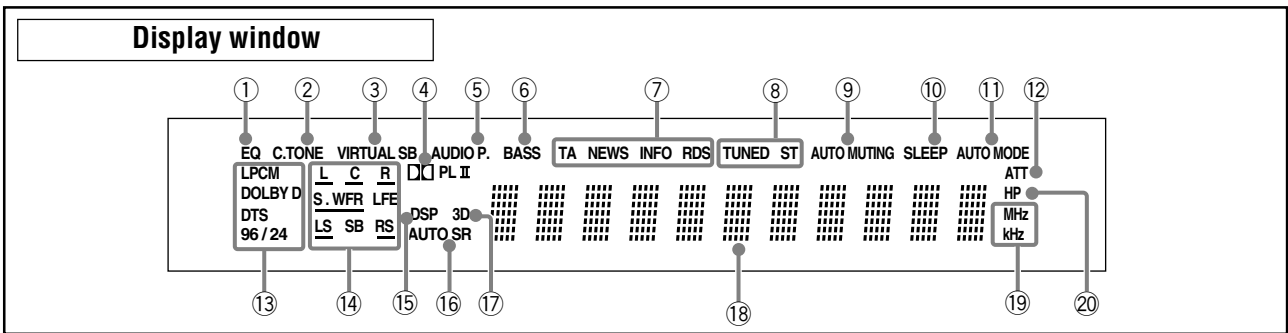

- |    |  |    |   |
|----|--|----|---|
| 1  | EQ indicator (22)  | 11 | AUTO MODE indicator (19)  |
| 2  | C.TONE indicator (21)                                    | 12 | ATT (attenuator) indicator (22)   |
| 3  | VIRTUAL SB indicator (18, 29, 30)                        | 13 | Digital signal format indicators (11)<br>LPCM (Linear PCM), DOLBY D (Dolby Digital), DTS, 96/24 |
| 4  | PL II indicator (29)                                     | 14 | Signal and speaker indicators (13)  |
| 5  | AUDIO P. (position) indicator (12)                       | 15 | DSP indicator (30, 31)  |
| 6  | BASS indicator (22)                                      | 16 | AUTO SR (surround) indicator (19)   |
| 7  | RDS operation indicators (25, 28)<br>TA, NEWS, INFO, RDS | 17 | 3D indicator (30, 31)   |
| 8  | Tuner operation indicators (23)<br>TUNED, ST (stereo)    | 18 | Main display  |
| 9  | AUTO MUTING indicator (24)                               | 19 | Frequency unit indicators<br>MHz (for FM station), kHz (for AM station)                         |
| 10 | SLEEP indicator (13)                                     | 20 | HP (headphones) indicator (11, 30, 31)  |

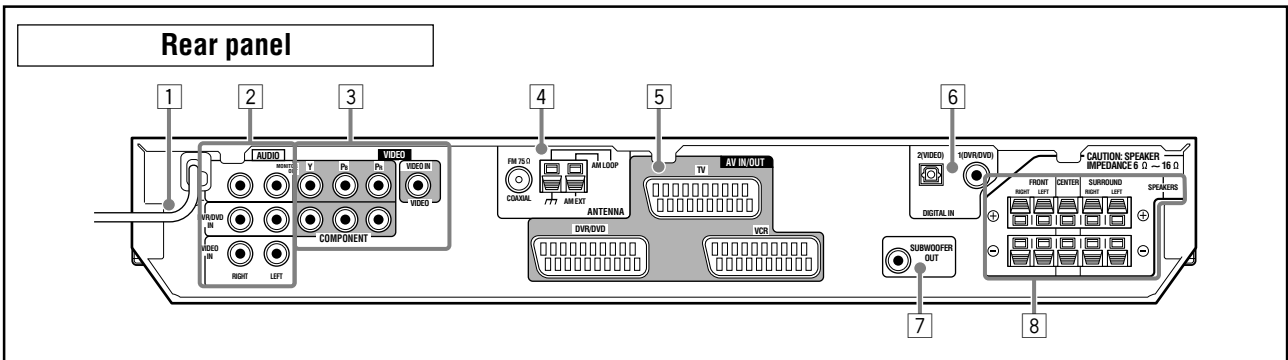

- |   |   |   |  |
|---|---|---|--|
| 1 | Power cord (9)  | 6 | DIGITAL IN terminals (9)<br>Coaxial: 1(DVR/DVD)<br>Optical: 2(VIDEO) |
| 2 | AUDIO jacks (8, 9)<br>MONITOR OUT, DVR/DVD IN, VIDEO IN   | 7 | SUBWOOFER OUT jack (6)   |
| 3 | VIDEO jacks (8, 9)<br>COMPOSITE (Y, PB, PR): MONITOR OUT, DVR/DVD IN<br>VIDEO (composite video): VIDEO IN | 8 | SPEAKERS terminals (6)<br>FRONT, CENTER, SURROUND                    |
| 4 | ANTENNA terminals (5)   |   |  |
| 5 | AV IN/OUT terminals (7)<br>TV, DVR/DVD, VCR   |   |  |

Parts identification

# Getting started

## Before Installation

### General precautions

- Be sure your hands are dry.
- Turn the power off to all components.
- Read the manuals supplied with the components you are going to connect.

### Locations

- Install the receiver in a location that is level and protected from moisture and dust.
- The temperature around the receiver must be between  $-5^{\circ}\text{C}$  and  $35^{\circ}\text{C}$ .
- Make sure there is good ventilation around the receiver. Poor ventilation could cause overheating and damage the receiver.

### Handling the receiver

- Do not insert any metal object into the receiver.
- Do not disassemble the receiver or remove screws, covers, or cabinet.
- Do not expose the receiver to rain or moisture.

**The receiver has a built-in cooling fan which operates while the receiver is turned on. Be sure to leave enough ventilation to obtain sufficient cooling effect.**

### CAUTION:

Do not connect the AC power plug to the wall outlet until all connections are completed.

## Checking the supplied accessories

Check to be sure you have all of the following supplied accessories. If anything is missing, contact your dealer immediately.

- Remote control (× 1)
- Batteries (× 2)
- AM (MW) loop antenna (× 1)
- FM antenna (× 1)
- SCART cable (× 1)
- Digital coaxial cable (× 1)

## Putting batteries in the remote control

Before using the remote control, put two supplied batteries first.

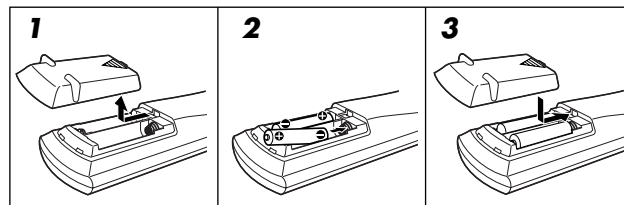

**1** Press and slide the battery cover on the back of the remote control.

**2** Insert batteries.

Make sure to match the polarity: (+) to (+) and (-) to (-).

**3** Replace the cover.

If the range or effectiveness of the remote control decreases, replace the batteries. Use two R6(SUM-3)/AA(15F) type dry-cell batteries.

- Supplied batteries are for initial setup. Replace for continued use.

### CAUTION:

Follow these precautions to avoid leaking or cracking cells:

- Place batteries in the remote control so they match the polarity: (+) to (+) and (-) to (-).
- Use the correct type of batteries. Batteries that look similar may differ in voltage.
- Always replace both batteries at the same time.
- Do not expose batteries to heat or flame.

When using the remote control, aim the remote control directly at the remote sensor on the front panel.

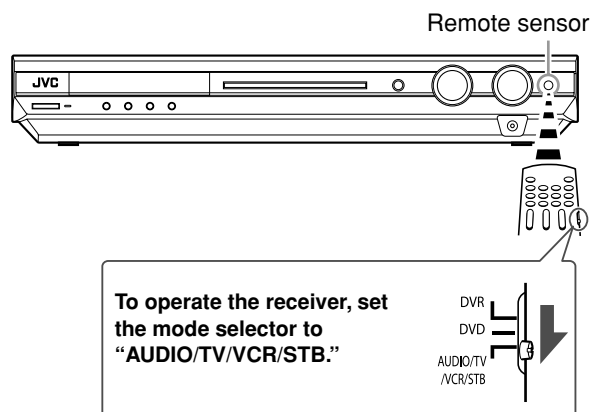



# Connecting the FM and AM (MW) antennas

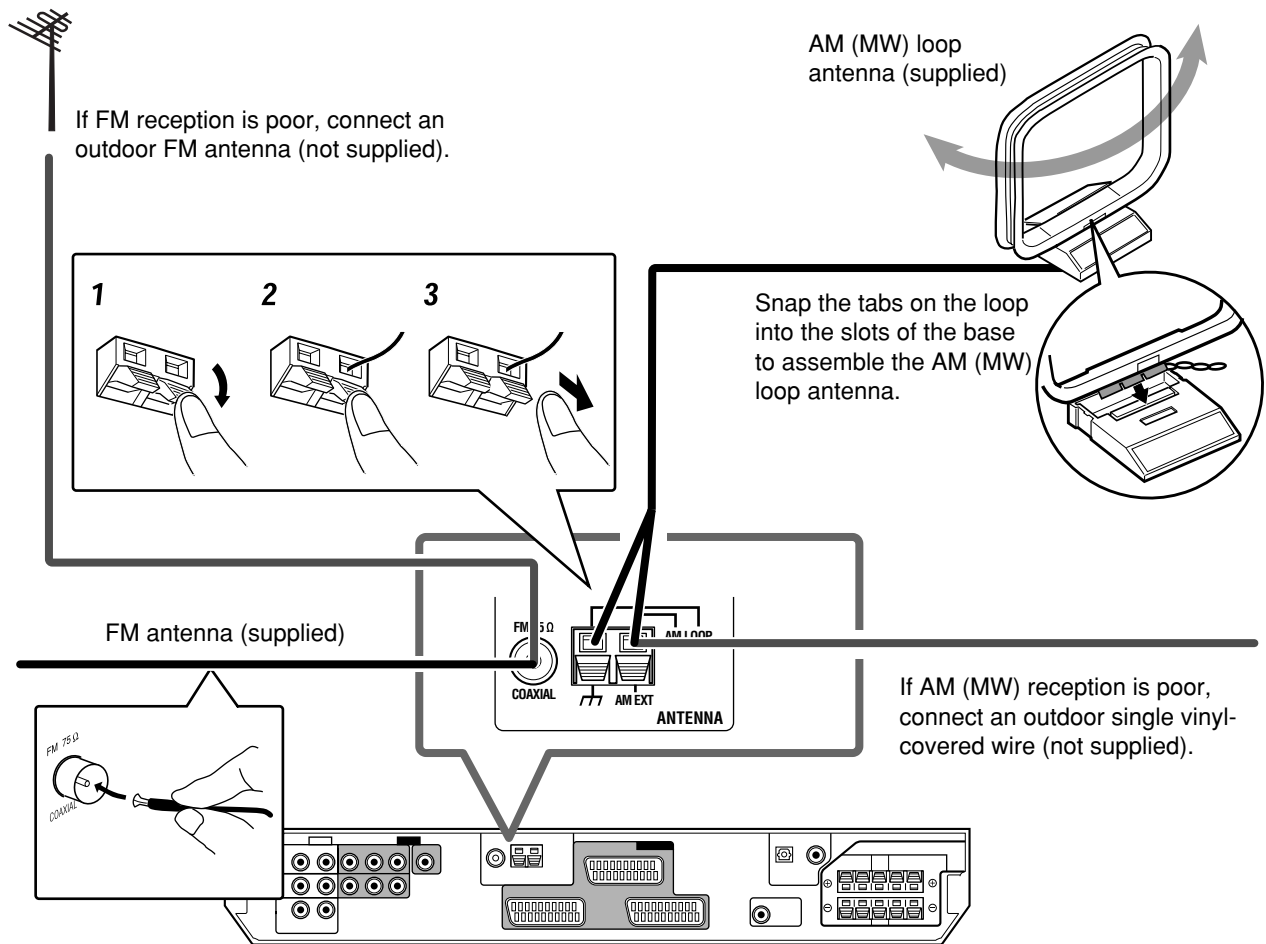

## AM (MW) antenna connection

Connect the AM (MW) loop antenna supplied to the AM LOOP terminals.  
 Turn the loop until you have the best reception.

- If the reception is poor, connect an outdoor single vinyl-covered wire (not supplied) to the AM EXT terminal. Keep the AM (MW) loop antenna connected.

## FM antenna connection

Connect the FM antenna supplied to the FM 75 Ω COAXIAL terminal as a temporary measure.  
 Extend the supplied FM antenna horizontally.

- If the reception is poor, connect an outdoor FM antenna (not supplied). Before attaching a 75 Ω coaxial cable with a connector (IEC or DIN 45325), disconnect the supplied FM antenna.

### NOTES

- If the AM (MW) loop antenna wire is covered with vinyl, remove the vinyl while twisting it as shown on the right.
- Make sure the antenna conductors do not touch any other terminals, connecting cords and power cord. This could cause poor reception.

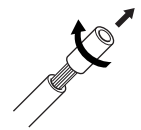

# Connecting the speakers

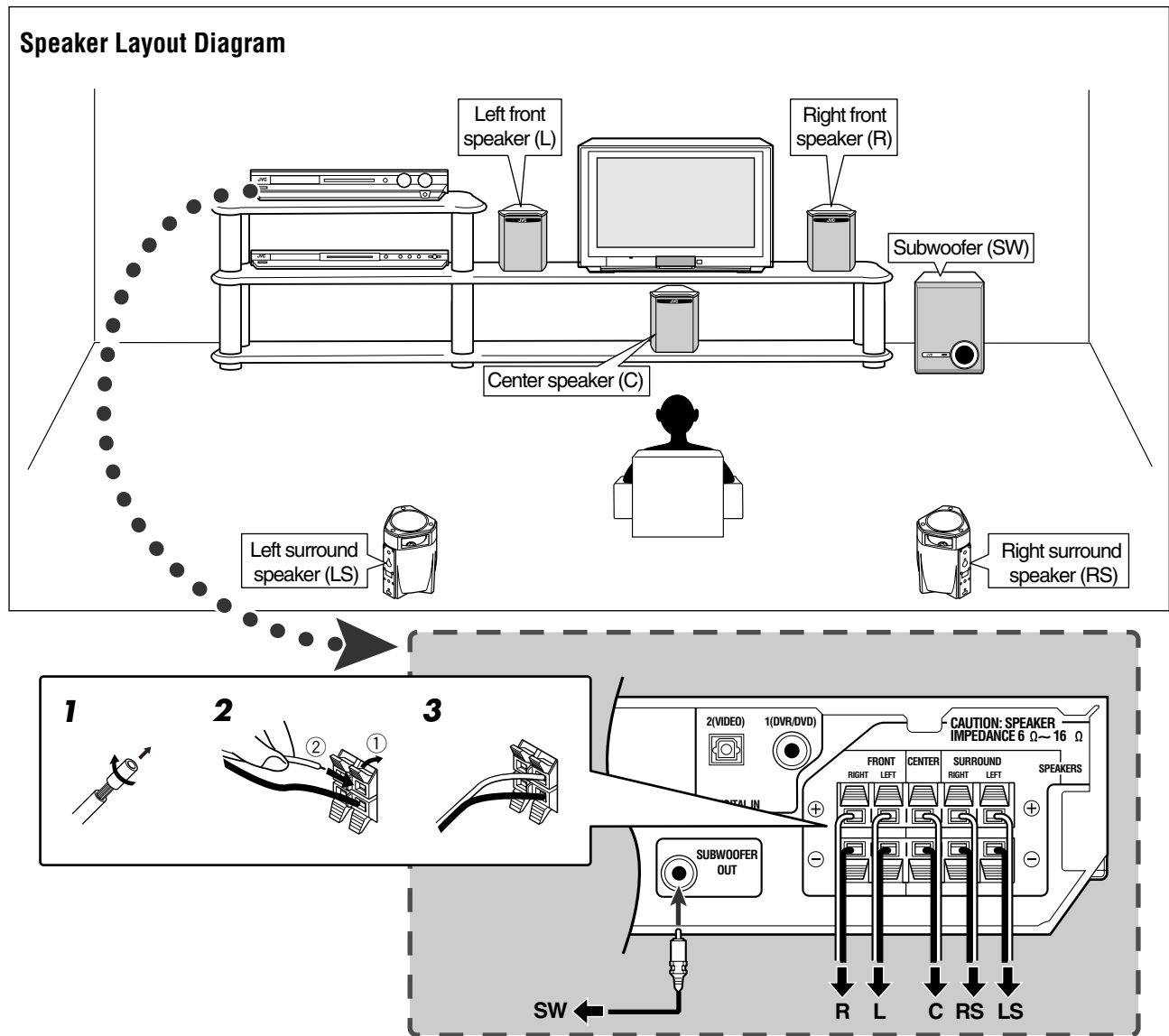

Getting started

## Connecting the front, center, and surround speakers

Turn off all components before making connections.

- 1** Twist and remove the insulation at the end of each speaker cord.
- 2** Press and hold the clamp of the speaker terminal (①), then insert the speaker cord (②).
  - For each speaker, connect the (+) and (-) terminals on the rear panel to the (+) and (-) terminals marked on the speakers.
- 3** Release the finger from the clamp.

### CAUTIONS:

- Use speakers with the SPEAKER IMPEDANCE indicated by the speaker terminals (6 Ω - 16 Ω).
- DO NOT connect more than one speaker to one speaker terminal.

## Connecting the subwoofer

By connecting a subwoofer, you can enhance the bass or reproduce the original LFE signals recorded in digital software.

**Connect the input jack of a powered subwoofer to the SUBWOOFER OUT jack on the rear panel, using a cord with RCA pin plugs (not supplied).**

- Refer also to the manual supplied with your subwoofer.

After connecting all the speakers and/or a subwoofer, set the speaker setting information properly to obtain the best possible surround effect. For details, see pages 14 to 17.

### NOTE

You can place a subwoofer wherever you like since bass sound is non-directional. Normally place it in front of you.

# Connecting video components

## SCART connection

You can enjoy pictures and sounds from playback components simply by connecting with the SCART cable.

- If your video components have digital output terminal, also connect them using the digital terminals explained in "Digital connection" (see page 9). By using these terminals, you can get better sound quality.

### CAUTION:

If you connect a sound-enhancing device such as a graphic equalizer between the source components and this receiver, the sound output through this receiver may be distorted.

**DO NOT use a TV through a VCR or a TV with a built-in VCR; otherwise, the picture may be distorted.**

### Turn off all components before making connections.

- Illustrations of the input/output terminals are typical examples. When you connect other components, refer also to their manuals since the terminal names actually printed on the rear vary among different components.

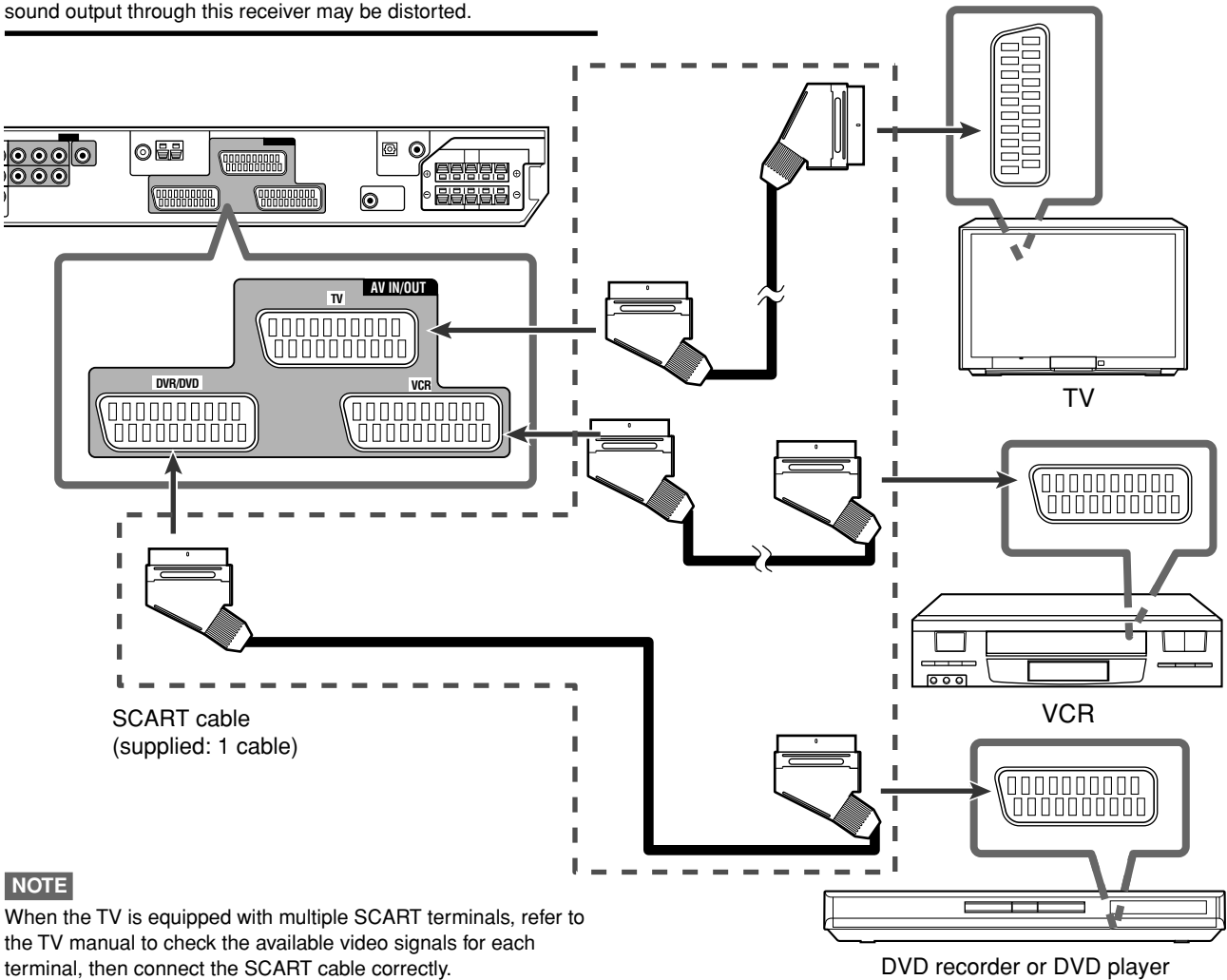

### NOTE

When the TV is equipped with multiple SCART terminals, refer to the TV manual to check the available video signals for each terminal, then connect the SCART cable correctly.

Getting started

**SCART Terminal Specifications**

				Terminal name		
				TV	VCR	DVR/DVD
Input	Audio	L/R	○	○	○	
	Video	Composite	○	○	○	
		S-video (Y/C)	-	○	○	
		RGB	-	○	○	
Output	Audio	L/R	○*1	○	○	
	Video	Composite	○*2*3	○*2*3	○*2*3	
		S-video (Y/C)	○*3	-	-	
		RGB	○*3	-	-	
T-V LINK			○*4	○*4	○*4	

○: Available    -: Not available

\*1 Only when TV Direct is in use (see page 12).

\*2 The signals input from a SCART terminal cannot be output through the same SCART terminal.

\*3 The video format of the output video signals are consistent with that of the input video signals. For example, if S-video signals are input to this receiver, no signals other than S-video signals can be output from this receiver. Refer to the manuals supplied with the video components to check the setting of the input/output video signals.

\*4 The signals for the T-V LINK function are always going through the receiver.

CONTINUED ON THE NEXT PAGE

**For TV and video format**

This receiver cannot convert the video signals. When the video signal of one video component is different from that of the other (for example, one is S-video, the other is Composite), you may not see the pictures appropriately. In this case, unify the video signals of all the video components, or you need to switch the video signal of TV each time you change the source.

**For an analogue decoder**

To watch through or to record a scrambled program on your VCR, connect the analogue decoder to your VCR and select the scrambled channel on your VCR. If there is not an appropriate terminal for the decoder connection on your VCR, connect the decoder to your TV. Refer also to the manuals supplied with these components.

**For T-V LINK**

- You can use the T-V LINK function if you connect a T-V LINK compatible TV and VCR to this receiver with a fully wired SCART cables. For details on T-V LINK, refer also to the manuals supplied with the TV and the VCR.
- Connect a SCART cable to EXT-2 terminal on the JVC's T-V LINK compatible TV for the T-V LINK function.
- Some video components support the data communication like T-V LINK. For complete details, refer also to the manuals supplied with these components.

**Audio/video connection**

In addition to the SCART terminals, this receiver is equipped with the following video terminals:

- Component video input/output: DVR/DVD IN, MONITOR OUT
- Composite video input: VIDEO IN

**NOTE**

When recording the sounds and pictures onto the DVD recorder or VCR, record them through the SCART terminals.

**IMPORTANT**

**The component video signals from the COMPONENT VIDEO jacks are transmitted only through the MONITOR OUT jacks.** Therefore, if the TV is connected to the receiver through the SCART terminal (TV) and a playing video component is connected to the receiver through the component video jacks (DVR/DVD IN), you cannot view the playback picture on the TV.

**■ Connecting a DVD recorder or DVD player to the DVR/DVD IN jacks**

To fully enjoy Dolby Digital and DTS multi-channel software (including Dual Mono software), connect the DVD recorder or DVD player through the digital input/output terminals (see page 9).

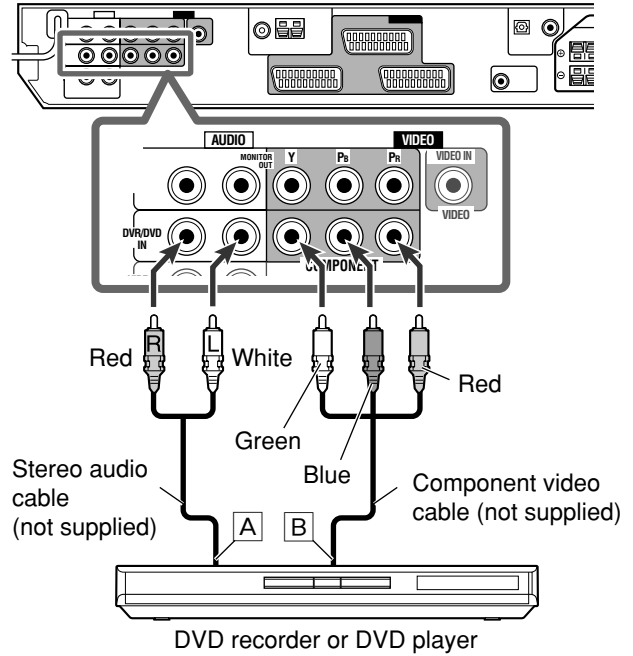

- A** To left/right audio channel output
- B** To component video output

**NOTES**

- Connect Y, Pb, and Pr correctly.
- Do not connect different components to the AUDIO DVR/DVD IN jacks and AV IN/OUT DVR/DVD terminal; otherwise, sounds from both components are come out of the speakers at the same time.

**■ Connecting a TV to the MONITOR OUT jacks**

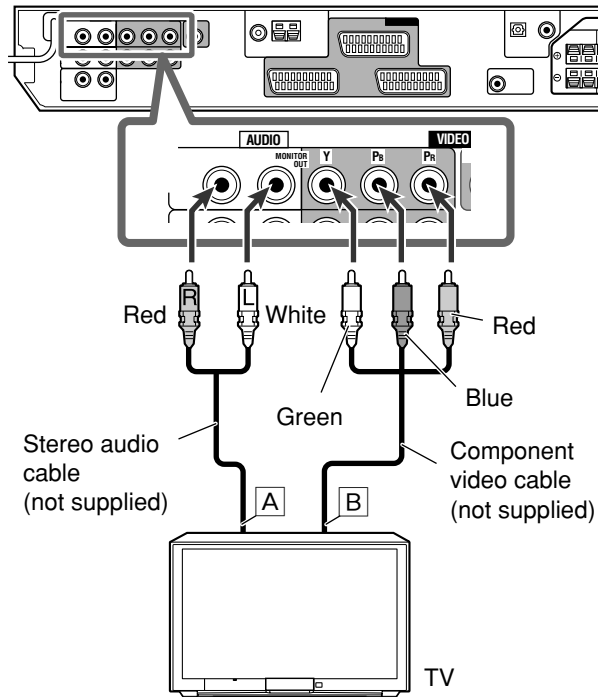

- A** To left/right audio channel input
- B** To component video input

**NOTES**

- Audio signals come out through the AUDIO MONITOR OUT (RIGHT/LEFT) jacks when TV Direct is in use (see page 12).
- Connect Y, Pb, and Pr correctly.

## ■ Connecting a video component to the VIDEO IN jacks

You can connect a video component such as another VCR to the VIDEO IN jacks using a composite video cable and stereo audio cable. Such component is referred to as the source "VIDEO" in this manual.

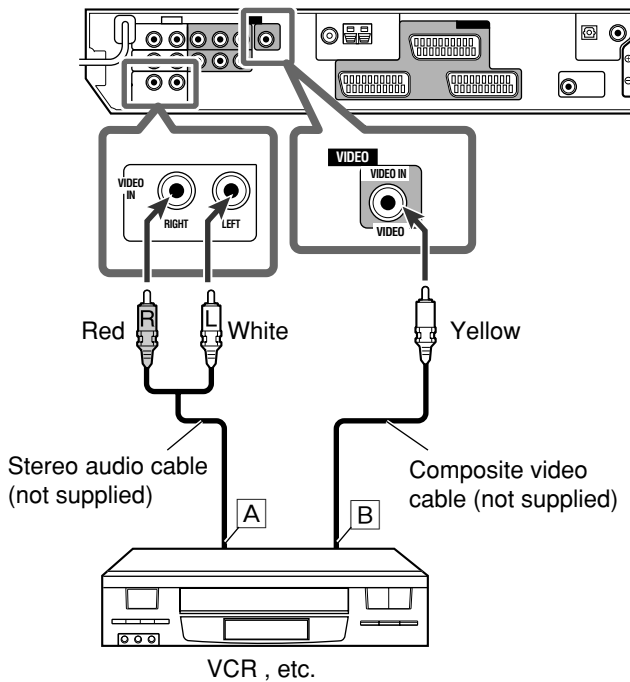

- A To left/right audio channel output
- B To composite video output

### NOTE

To view the picture, connect the TV to the receiver using the SCART cable.

## Digital connection

This receiver is equipped with two DIGITAL IN terminals—a digital coaxial terminal and digital optical terminal.

To reproduce the digital sound, use the digital connection in addition to the analogue connection methods described on pages 7 to 9.

Digital coaxial cable (supplied: 1 cable)



Digital optical cable (not supplied)

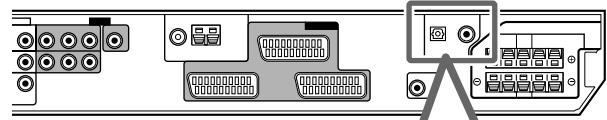

When the component has a digital coaxial output terminal, connect it to the 1(DVR/DVD) terminal, using a digital coaxial cable (supplied).

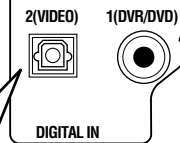

When the component has a digital optical output terminal, connect it to the 2(VIDEO) terminal, using a digital optical cable (not supplied).

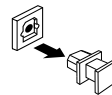

Before connecting a digital optical cable, unplug the protective plug.

### NOTES

- When shipped from the factory, the DIGITAL IN terminals have been set for use with the following components:
  - 1(DVR/DVD): For DVD recorder or DVD player
  - 2(VIDEO): For the component connected to the VIDEO IN jacks

If you connect other components, change the digital input (DIGITAL IN) terminal setting correctly. See "Setting the digital input (DIGITAL IN) terminals—DIGITAL IN1/2" on page 19.

- Select the correct digital input mode. See "Selecting the analogue or digital input mode" on page 10.

## Connecting the power cord

When all the audio/video connections have been made, connect the AC power plug to the wall outlet. Make sure that the plugs are inserted firmly. The standby lamp lights in red.

### CAUTIONS:

- Do not touch the power cord with wet hands.
- Do not alter, twist or pull the power cord, or put anything heavy on it, which may cause fire, electric shock, or other accidents.
- If the cord is damaged, consult a dealer and have the power cord replaced with a new one.

### NOTES

- Keep the power cord away from the connecting cables and the antenna. The power cord may cause noise or screen interference.
- The preset settings such as preset channels and sound adjustment may be erased in a few days in the following cases:
  - When you unplug the power cord.
  - When a power failure occurs.

# Basic operations

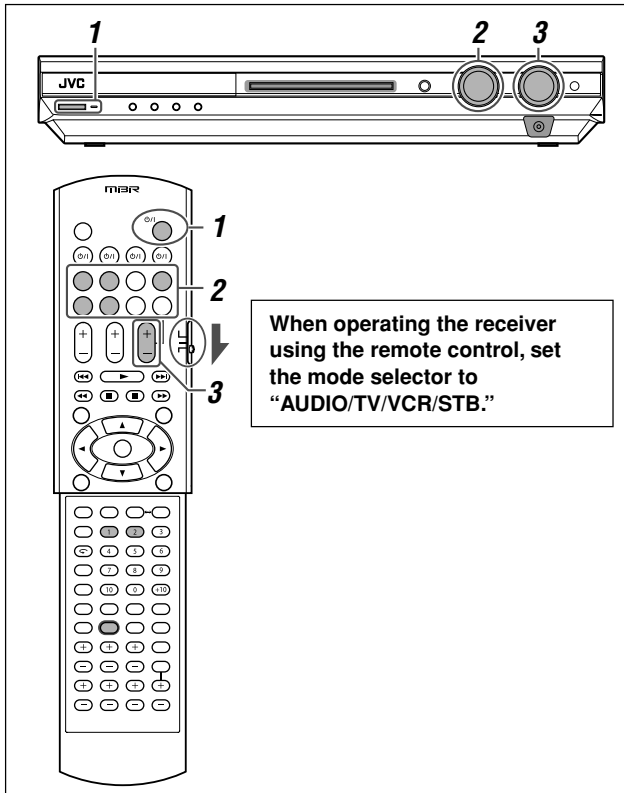

## 1 Turn on the power

Press **STANDBY/ON** (or **AUDIO** on the remote control).

The standby lamp goes off and the source lamp of the current source lights in red.

Current source name appears.

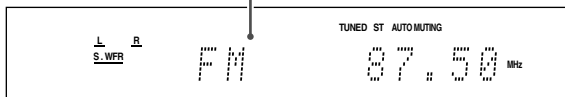

### To turn off the power (into standby)

Press **STANDBY/ON** (or **AUDIO** on the remote control) again.

The standby lamp lights in red.

#### NOTE

A small amount of power is consumed in standby mode. To turn the power off completely, unplug the AC power cord.

## 2 Select the source to play

**On the front panel:**

Turn **SOURCE SELECTOR** until the source name you want appears on the display.

The source lamp corresponding to the selected source lights in red.

- As you turn **SOURCE SELECTOR**, the source changes as follows:



DVR/DVD (DGT) ↔ VCR (DIGITAL) ↔  
VIDEO (DGTL) ↔ TV (DIGITAL) ↔  
FM ↔ AM ↔ (Back to the beginning)

- DVR/DVD (DGT)\*: Select the DVD recorder or DVD player.
- VCR (DIGITAL)\*: Select the VCR.
- VIDEO (DGTL)\*: Select the component connected to the VIDEO IN jacks on the rear of the receiver.
- TV (DIGITAL)\*: Select the TV.
- FM: Select an FM broadcast.
- AM: Select an AM (MW) broadcast.

**From the remote control:**

Press one of the source selecting buttons.

- For the tuner, press FM/AM. Each time you press FM/AM, the band alternates between FM and AM (MW).

### \* Selecting the analogue or digital input mode

For a component you have connected using both the analogue connection and the digital connection methods (see pages 7 to 9), you need to select the correct input mode.

- You can select the digital input only for sources which you have selected digital input terminals for. (See "Setting the digital input (DIGITAL IN) terminals—DIGITAL IN1/2" on page 19.)

**From the remote control ONLY:**

Press **SOUND**, then press **A/D INPUT** to select the analogue or digital input mode.

- Each time you press **A/D INPUT**, the input mode alternates between the analogue input ("ANALOGUE") and the digital input ("DGTL AUTO").

**DGTL AUTO:** Select for the digital input mode. The receiver automatically detects the incoming signal format, then the digital signal format indicator (LPCM, DOLBY D, DTS, or DTS 96/24) for the detected signal lights up.

**ANALOGUE:** Select for the analogue input mode.

**Initial setting:** ANALOGUE

#### NOTE

After pressing **SOUND**, the numeric buttons work for sound adjustments. To use the numeric buttons to operate your target source, press the corresponding source selecting button before operation; otherwise, the remote control may not work as you intend.

### 3 Adjust the volume

To increase the volume, turn **MASTER VOLUME** control clockwise (or press **VOLUME +** on the remote control).

To decrease the volume, turn **MASTER VOLUME** control counterclockwise (or press **VOLUME -** on the remote control).

- When you adjust the volume, the volume level indication appears on the display for a while.

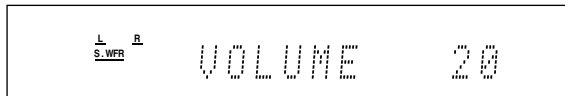

#### CAUTION:

Always set the volume to the minimum before starting any sources. If the volume is set at its high level, the sudden blast of sound energy can permanently damage your hearing and/or ruin your speakers.

#### NOTE

The volume level can be adjusted within the range of "0" (minimum) to "50" (maximum).

### Listening with headphones

You can enjoy not only stereo software but also multi-channel software through the headphones. (Sounds are down-mixed to the front channels while playing multi-channel software.)

**Connect a pair of headphones to the PHONES jack on the front panel to activate the HEADPHONE mode.**

- The HP (headphone) indicator lights up on the display.
- You can also enjoy the Surround/DSP mode through the headphones—3D HEADPHONE mode. For details, see pages 30 and 31.
- Disconnecting a pair of headphones from the PHONES jack cancels the HEADPHONE (or 3D HEADPHONE) mode and activates the speakers.

#### CAUTION:

Be sure to turn down the volume:

- Before connecting or putting on headphones, as high volume can damage both the headphones and your hearing.
- Before removing headphones, as high volume may output from the speakers.

### Selecting the digital decode mode

If the following symptoms occur while playing Dolby Digital or DTS software with "DGTL AUTO" selected (see page 10), follow the procedure below:

- Sound does not come out at the beginning of playback.
- Noise comes out while searching for or skipping chapters or tracks.

**From the remote control ONLY:**

**1 Press SOUND, then press A/D INPUT to select "DGTL AUTO."**

**2 Press DECODE to select "DGTL D.D." or "DGTL DTS."**

- Each time you press the button, the digital decode mode changes as follows:

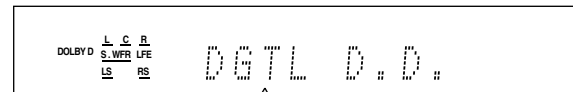

DGTL AUTO → DGTL D.D. →  
DGTL DTS → (Back to the beginning)

- To play back software encoded with Dolby Digital, select "DGTL D.D."
- To play back software encoded with DTS, select "DGTL DTS."

#### NOTES

- When you turn off the power or select another source, "DGTL D.D." or "DGTL DTS" is canceled and the digital decode mode is automatically reset to "DGTL AUTO."
- After pressing SOUND, the numeric buttons work for sound adjustments. To use the numeric buttons to operate your target source, press the corresponding source selecting button before operation; otherwise, the remote control may not work as you intend.

The following digital signal format indicators on the display indicate what type of signal comes into the receiver.

**LPCM:** Lights up when Linear PCM signal comes in.

**DOLBY D:** • Lights up when Dolby Digital signal comes in.  
• Flashes when "DGTL D.D." is selected for any software other than Dolby Digital.

**DTS:** • Lights up when conventional DTS signal comes in.  
• Flashes when "DGTL DTS" is selected for any software other than DTS.

**DTS 96/24:** Lights up when DTS 96/24 signal comes in.

#### NOTE

When "DGTL AUTO" cannot recognize the incoming signal, no digital signal format indicator lights up on the display.

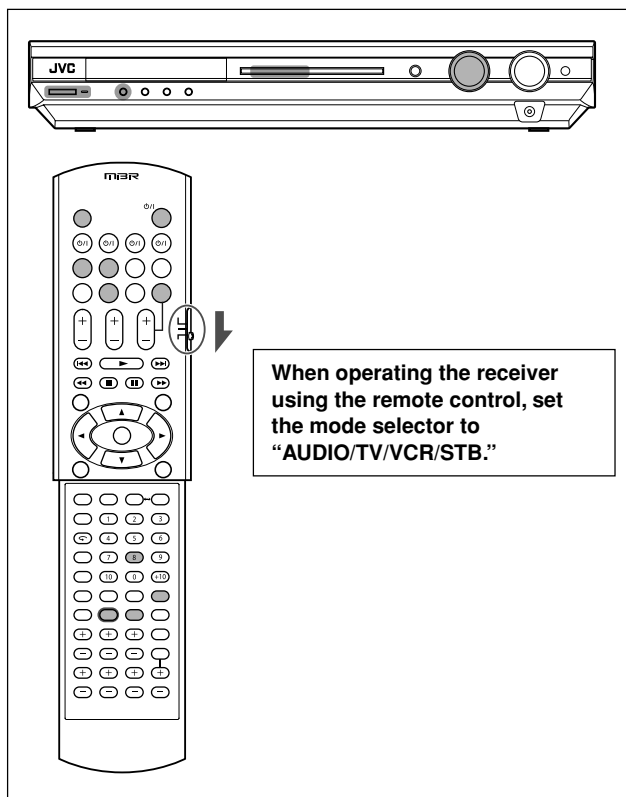

## Adjusting the subwoofer audio position

If the subwoofer sound is reinforced for stereo sound compared to the sound reproduced with multi-channel, set the subwoofer audio position. The subwoofer output level is automatically decreased by the selected value when you are listening in stereo.

The AUDIO P. indicator lights up when this function is activated.

- Once you have made an adjustment, it is memorized for each source.

### From the remote control ONLY:

#### Press SOUND, then press A.POSITION repeatedly.

- Each time you press A.POSITION, the subwoofer audio position level changes as follows:

AUDIO P. indicator

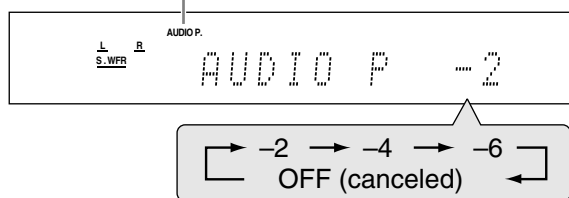

The smaller the number becomes, the more the level decreases automatically when listening in stereo.

- If no adjustment is required, select "OFF" (initial setting).

### NOTES

- The maximum subwoofer output level is  $-10$  dB.  
Ex.: When setting the subwoofer output level to " $-8$  (dB)" and the subwoofer audio position to " $-4$  (dB)," the subwoofer output level when listening in stereo will be  $-10$  dB.  
To adjust the subwoofer output level, see page 21.
- This function is not available when the Surround/DSP mode is activated.
- After pressing SOUND, the numeric buttons work for sound adjustments. To use the numeric buttons to operate your target source, press the corresponding source selecting button before operation; otherwise, the remote control may not work as you intend.

## Activating TV Direct

TV Direct enables you to use this receiver as an AV selector **while the receiver is turned off.**

When TV Direct is activated, the pictures and sounds go from the video components such as DVD player to the TV through this receiver. Thus, you can use the video components and the TV as if they were connected directly.

- This function takes effect for the following sources—DVR/DVD, VCR, and VIDEO.

To activate (or deactivate) TV Direct, follow the procedure below:

### 1 Press TV DIRECT.

All the indications disappear, then the source lamp of the current source lights in green.

### 2 Turn on the video component and TV.

### 3 Select the target video component.

#### On the front panel:

Turn SOURCE SELECTOR until one of the source lamps—DVR/DVD, VCR, or VIDEO—lights in green.

#### From the remote control:

Press one of the source selecting buttons—DVR/DVD, VCR, or VIDEO.

The source lamp corresponding to the selected source lights in green.

To cancel TV Direct and turn off the receiver, press  $\text{O/I}$  STANDBY/ON on the front panel (or  $\text{O/I}$  AUDIO on the remote control).

The receiver is turned off and the standby lamp lights up.

To cancel TV Direct and turn on the receiver, press TV DIRECT again.

The receiver is turned on and the source lamp currently selected lights in red.

### NOTES

- When TV Direct is activated, you cannot enjoy any of the sound effects the receiver produces, and cannot use the speakers connected to the receiver.
- You can use the T-V LINK function between the TV and VCR while TV Direct is activated. (For T-V LINK functions, refer to the manuals supplied with the TV and the VCR.)



## Turning off the sounds temporarily

### From the remote control **ONLY**:

Press **MUTING** to turn off the sound through all connected speakers and headphones connected.

"MUTING" appears on the display and the volume turns off.



To restore the sound, press **MUTING** again.

- Pressing **VOLUME +/-** (or turning **MASTER VOLUME** control on the front panel) also restores the sound.

## Changing the display brightness

You can dim the display—Dimmer.

### From the remote control **ONLY**:

Press **DIMMER** repeatedly.

- Each time you press the button, the display brightness changes as follows:
  - DIMMER 1: Dims the display slightly.
  - DIMMER 2: Dims the display more than DIMMER 1.
  - DIMMER 3: Turns off the display. (Temporarily canceled when you operate the receiver\*.)
- DIMMER OFF: Cancels the Dimmer (normal display).

\* Except when activating or deactivating TV Direct.

## Turning off the power with the Sleep Timer

You can fall asleep while listening to music—Sleep Timer.

### From the remote control **ONLY**:

Press **SLEEP** repeatedly.

- Each time you press the button, the shut-off time changes in 10 minute intervals. The **SLEEP** indicator lights up on the display.

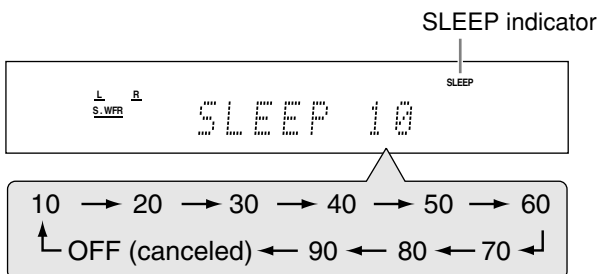

### When the shut-off time comes:

The receiver turns off automatically.

### To check or change the remaining time until the shut-off time:

Press **SLEEP** once.

The remaining time (in minutes) until the shut-off time appears.

- To change the shut-off time, press **SLEEP** repeatedly.

### To cancel the Sleep Timer:

Press **SLEEP** repeatedly so that "SLEEP OFF" appears on the display. (The **SLEEP** indicator goes off.)

- The Sleep Timer is also canceled when:
  - You turn off the receiver, or
  - TV Direct is activated.

## Basic adjustment of auto memory

This receiver memorizes sound settings for each source:

- when you turn off the power,
- when you change the source, and
- when you change the analogue/digital input mode (see page 10).

When you change the source, the memorized settings for the newly selected source are automatically recalled.

The following can be stored for each source:

- Analogue/digital input mode (see page 10)
- Speaker output level (see page 21)
- Subwoofer audio position (see page 12)
- Subwoofer phase (see page 22)
- Digital equalization pattern (see page 22)
- Bass boost (see page 22)
- Input attenuator mode (see page 22)
- Surround/DSP mode selection (see pages 32 and 33)

### NOTE

If the source is FM or AM (MW), you can assign a different setting for each band.

## Signal and speaker indicators on the display

Signal indicators

Speaker indicators

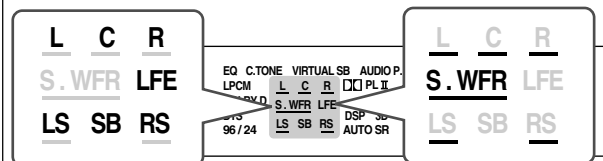

### The signal indicators light up as follows:

- L:
  - **When digital input is selected:** Lights up when the left channel signal comes in.
  - **When analogue input is selected:** Always lights up.
- R:
  - **When digital input is selected:** Lights up when the right channel signal comes in.
  - **When analogue input is selected:** Always lights up.
- C: Lights up when the center channel signal comes in.
- LS\*: Lights up when the left surround channel signal comes in.
- RS\*: Lights up when the right surround channel signal comes in.
- SB: Lights up when the surround back channel signal comes in.
- LFE: Lights up when the LFE channel signal comes in.

\* When monaural surround signal comes in, only "S" lights up.

### The speaker indicators light up as follows:

- The subwoofer indicator (**S.WFR**) lights up when "SUBWOOFER" is set to "SUBWFR :YES." For details, see page 16.
- The other speaker indicators light up only when the corresponding speaker is set to "SML (small)" or "LRG (large)," and also when required for the current playback.

# Basic settings

To obtain the best possible sound effect from Surround/DSP modes (see pages 29 to 33), you need to set up the speaker and subwoofer information after all the connections are completed. From pages 14 to 19, how to set speakers and other basic items of the receiver are explained.

## Setting the speaker information automatically—Smart Surround Setup

The distance from your listening point to the speakers is one of the important elements to obtain the best possible sound effect for the Surround/DSP modes.

By using Smart Surround Setup, the following are automatically calculated by one simple action—clapping hands.

- Speaker distance (compared to that of the closest speaker)
- Speaker output level

### NOTES

- Before starting Smart Surround Setup, set the speaker information correctly (SML, LRG, or NO) according to your speakers except the subwoofer (see page 16).
- When the setting is made by Smart Surround Setup, the speaker distance and output level you have set before will be inactive.
- If you have turned off the display, cancel the Dimmer (see page 13); otherwise, you cannot see the information on the display during Smart Surround Setup.
- Smart Surround Setup will not be done correctly if you or other object blocks the sound.
- When you change your speakers, do the following procedure again.

### From the remote control ONLY:

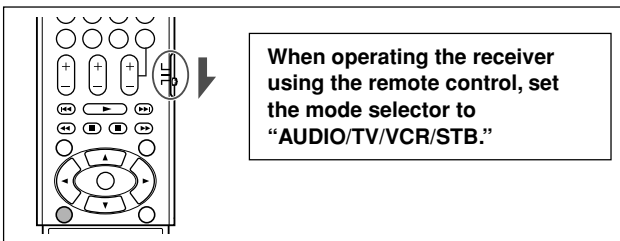

### 1 Take your position where you listen to the sound.

- Make sure speaker cables are connected firmly.

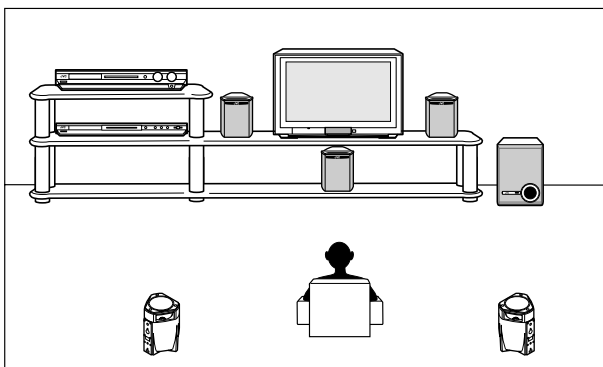

### 2 Press and hold SMART SURROUND SETUP until “SETTING UP” flashes on the display.

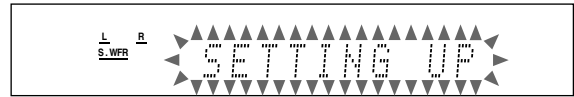

### 3 Confirm that “SETTING UP” stops flashing, then clap your hands over your head once while “SETTING UP” still remains on the display.

The receiver starts detecting the level of the sound coming through each speakers (except the subwoofer).

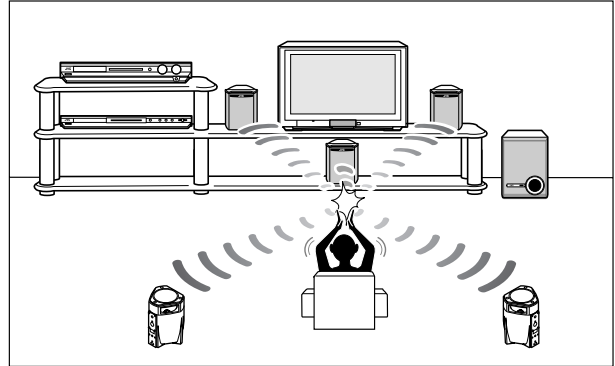

### When your clapping sound is detected successfully,

“SUCCESSFUL” appears on the display, then the values set are shown as follows:

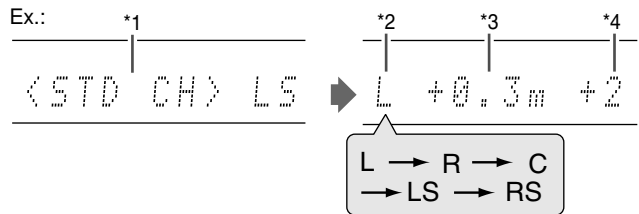

► COMPLETED ► Then the receiver returns to normal operation mode.

- \*1 Standard channel (the closest speaker). This speaker position now works as the reference position (“0m/ft”) and other speakers’ distance is shown by the difference with this reference speaker position.
- \*2 **L:** Left front speaker  
**R:** Right front speaker  
**C:** Center speaker  
**LS:** Left surround speaker  
**RS:** Right surround speaker
- \*3 Difference of each speaker position in distance (in meters or feet).
- \*4 Each speaker’s output level (–6 to +6).

### When your clapping sound is not detected correctly,

“SETTING UP” appears again after one of the following messages appears on the display.

- SILENT:**
  - The receiver detects sound from only the left and right front speakers.
  - The receiver detects no sound from the front speakers and detects sound from at least one of other speakers.
- SILENT-ALL:** The receiver cannot detect any sound from any speakers for about 15 seconds.
- FAILED:** The receiver cannot detect sound from the left or right front speaker.

In this case, repeat step 3.

In the following cases, set the speakers manually.

- **When the receiver detects the sound as “SILENT” twice in succession.**

The setting is made. (The distance of the speakers from which sound has not been detected is set to “+9.0m (+30ft).”) The receiver exits from Smart Surround Setup.

- **When the receiver fails to detect the sound three times.**

“MANUAL” appears on the display. The receiver exits from Smart Surround Setup.

**To cancel Smart Surround Setup**, press SMART SURROUND SETUP while “SETTING UP” flashes on the display.

- No other operations can be done after “SETTING UP” stops flashing. Complete the Smart Surround Setup.

**To check the setting made by Smart Surround Setup**, press SMART SURROUND SETUP while the receiver is in normal operation mode.

The setting values appear one after another (see page 14).

- If you have changed speaker distance and/or output level manually after using Smart Surround Setup, “MANUAL” appears.
- If you have not used Smart Surround Setup, “NO S.S.S.” appears.

#### NOTES

- The speaker distance and output level manually set will be applied instead of those set by using Smart Surround Setup in the following cases:
  - When you change one of the speaker distance (see page 17).
  - When you change one of the speaker output level (see page 21).
  - When you change one of the speaker size either from “NO” to “SML” or “LRG,” or from “SML” or “LRG” to “NO” (see page 16).
- When you want to adjust the speaker distance and output level manually, see pages 17 and 21.
- Do not clap your hands so hard that it may hurt your hands.

## Basic setting items

You can adjust the following items. See pages in parentheses for details.

- You cannot select the items which is not available with the current setting.

Items	To do
<b>SUBWOOFER</b>	Register your subwoofer. (16)
<b>FRONT SPK</b>	Register your front speaker size. (16)
<b>CENTER SPK</b>	Register your center speaker size. (16)
<b>SURRND SPK</b>	Register your surround speaker size. (16)
<b>DIST UNIT</b>	Select the measuring unit for the speaker distance. (17)
<b>FRNT L DIST*</b>	Register the distance from the left front speaker to your listening point. (17)
<b>FRNT R DIST*</b>	Register the distance from the right front speaker to your listening point. (17)
<b>CENTER DIST*</b>	Register the distance from the center speaker to your listening point. (17)
<b>SURR L DIST*</b>	Register the distance from the left surround speaker to your listening point. (17)
<b>SURR R DIST*</b>	Register the distance from the right surround speaker to your listening point. (17)
<b>SUBWFR OUT</b>	Select sounds emitted from the subwoofer. (17)
<b>VIRTUAL SB</b>	Set the virtual surround back speaker. (18)
<b>DUAL MONO</b>	Select the Dual Mono sound channel. (18)
<b>CROSS OVER</b>	Select the cutoff frequency to the subwoofer. (17)
<b>LFE ATT</b>	Attenuate the bass (LFE) sounds. (17)
<b>MIDNIGHT M.</b>	Reproduce a powerful sound at night. (18)
<b>DIGITAL IN1</b>	Select the component connected to the digital coaxial terminal. (19)
<b>DIGITAL IN2</b>	Select the component connected to the digital optical terminal. (19)
<b>AUTO SURRND</b>	Select Auto Surround mode. (19)
<b>AUTO MODE</b>	Select Auto Function mode. (19)

\* If you have used Smart Surround Setup on page 14, these settings are not required.

# Operating procedure

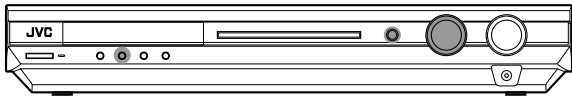

## On the front panel ONLY:

### Before you start, remember...

There is a time limit in doing the following steps. If the setting is canceled before you finish, start from step 1 again.

Ex.: When setting DIGITAL IN 1 terminal.

### 1 Press SETTING.

MULTI JOG now works for the setting operation.

### 2 Turn MULTI JOG until the item you want to set appears on the display.

- As you turn MULTI JOG, the setting items change as follows:

L S.WFR R
DIGITAL IN1

SUBWOOFER	↔	FRONT SPK	↔
CENTER SPK	↔	SURRND SPK	↔
DIST UNIT	↔	FRNT L DIST	↔
FRNT R DIST	↔	CENTER DIST	↔
SURR L DIST	↔	SURR R DIST	↔
SUBWFR OUT	↔	VIRTUAL SB	↔
DUAL MONO	↔	CROSS OVER	↔
LFE ATT	↔	MIDNIGHT M.	↔
DIGITAL IN1	↔	DIGITAL IN2	↔
AUTO SURRND	↔	AUTO MODE	↔

(Back to the beginning)

### 3 Press SET.

The current setting of the selected item appears.

L S.WFR R
D1 DVR/DVD

### 4 Turn MULTI JOG to select the appropriate setting.

L S.WFR R
D1 VCR

→ DVR/DVD ↔ VIDEO ←

→ TV ↔ VCR ←

Your setting is stored.

### 5 Press SET.

### 6 Repeat steps 2 to 5 to set other items if necessary.

# Setting the speakers

## Setting subwoofer information—SUBWOOFER

Each time the receiver turns on, the receiver detects the subwoofer connection and automatically changes the setting of the subwoofer.

When you want to change the setting manually, select either one below.

**SUBWFR : YES** Select when you have connected a subwoofer. The subwoofer indicator (**S.WFR**) lights up on the display. You can adjust the subwoofer output level (see page 21).

**SUBWFR : NO** Select when you have disconnected a subwoofer. Selecting this changes the front speaker size to "LRG" (see below).

### NOTE

You need to change the setting each time turning on the receiver if you want to change the subwoofer information set automatically.

## Setting the speaker size—FRONT SPK (front speakers), CENTER SPK (center speaker), SURRND SPK (surround speakers)

Register the sizes of all the connected speakers.

<b>LRG (large)</b>	Select when the cone speaker size is larger than 12 cm.
<b>SML (small)</b>	Select when the cone speaker size is smaller than 12 cm.
<b>NO</b>	Select when you have disconnected a speaker. (Not selectable for the front speakers.)

**Initial setting:** SML for all speakers\*

\* When "SUBWOOFER" is set to "SUBWFR : NO," the front speaker size is fixed to "LRG" (and you cannot select "SML").

### NOTES

- If you have selected "SML (small)" for the front speaker size, you cannot select "LRG (large)" for the center and surround speaker sizes.
- If you change the center and/or surround speaker size either from "NO" to "SML" or "LRG," or from "SML" or "LRG" to "NO," the distance and output levels set by Smart Surround Setup will be cleared.

## Setting the speaker distance

The distance from your listening point to the speakers is one of the important elements to obtain the best possible sound effect from the Surround/DSP modes.

By referring to the speaker distance, the receiver automatically sets the delay time of the sound through each speaker so that sounds through all the speakers can reach you at the same time.

- If you have used Smart Surround Setup on page 14, this setting is not required.

### ■ Measuring unit—DIST UNIT

Select which measuring unit you use.

**UNIT :meter** Select to set the distance in meters.

**UNIT : feet** Select to set the distance in feet.

**Initial setting:** UNIT :meter

### ■ Speaker distance—

**FRNT L DIST (for the left front speaker),**  
**FRNT R DIST (for the right front speaker),**  
**CENTER DIST (for the center speaker),**  
**SURR L DIST (for the left surround speaker),**  
**SURR R DIST (for the right surround speaker)**

**Adjustable range:** 0.3 m to 9.0 m in 0.3 m intervals  
 (1 ft to 30 ft in 1 ft intervals)

**Initial setting:** 3.0 m (10 ft) for all speakers

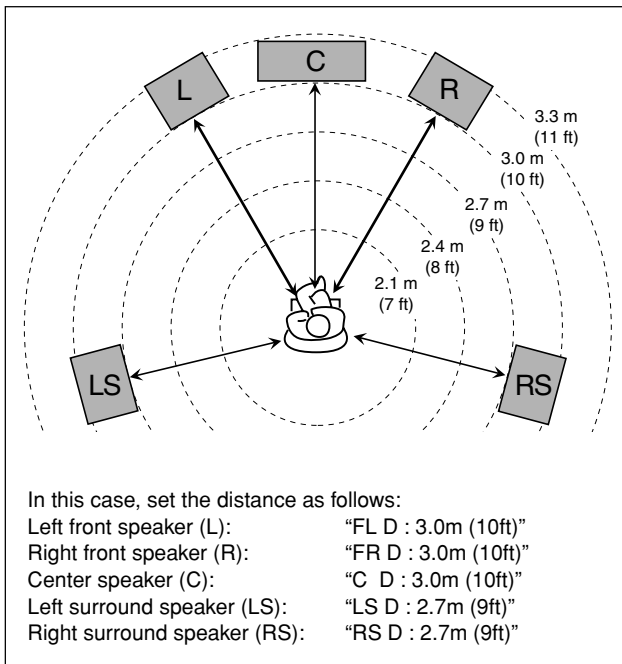

### NOTES

- You cannot set the speaker distance for the speakers you have set to "NO."
- If you change speaker distance, the distance and output level set manually will be applied instead of those set by Smart Surround Setup.

## Setting bass sound

### Setting subwoofer output—SUBWFR OUT

You can select the type of the signal which can be transmitted through the subwoofer. In other words, you can determine whether or not the bass elements of the front speaker channels are transmitted through the subwoofer regardless of the front speaker size setting (either "SML" or "LRG").

**SW: LFE**

Select to emit only the LFE signals (while playing Dolby Digital and DTS software) or the bass elements of the "SML (small)" front speakers (while playing any source other than above).

**SW:LFE+MAIN**

Select to always emit the bass elements of the front speaker channels (MAIN). While playing Dolby Digital and DTS software, the bass elements and the LFE signals are both emitted.

**Initial setting:** SW: LFE

### NOTE

When "SUBWOOFER" is set to "SUBWFR : NO" (see page 16), this function is not available.

### Setting the crossover frequency—CROSS OVER

Small speakers cannot reproduce the bass sounds efficiently. If you use a small speaker in any position, this receiver automatically reallocates the bass sound elements assigned to the small speaker to the large speakers.

To use this function properly, set this crossover frequency level according to the size of the small speaker connected.

- If you have selected "LRG (large)" for all speakers (see page 16), this function will not take effect ("CROSS: OFF" appears).

**CROSS: 80Hz**

Select when the cone speaker unit built in the speaker is about 12 cm.

**CROSS:100Hz**

Select when the cone speaker unit built in the speaker is about 10 cm.

**CROSS:120Hz**

Select when the cone speaker unit built in the speaker is about 8 cm.

**CROSS:150Hz**

Select when the cone speaker unit built in the speaker is about 6 cm.

**CROSS:200Hz**

Select when the cone speaker unit built in the speaker is less than 5 cm.

**Initial setting:** CROSS:150Hz

### NOTE

Crossover frequency is not valid for the HEADPHONE and 3D HEADPHONE modes.

### Setting the low frequency effect attenuator—LFE ATT

If the bass sound is distorted while playing back software encoded with **Dolby Digital** or **DTS**, set the LFE level to eliminate distortion.

- This function takes effect only when the LFE signals come in.

**LFE : 0dB**

Normally select this.

**LFE : -10dB**

Select when the bass sound is distorted.

**Initial setting:** LFE : 0dB

## Setting the virtual surround back speaker—VIRTUAL SB

You can enjoy the surround back channel while playing back **Dolby Digital EX** software or **DTS-ES** software without the surround back speaker—Virtual Surround Back. This function creates the great surround effect from the behind as if you have connected the surround back speaker.  
Select "V SB : ON" when activating the Virtual Surround Back.

<b>V SB : OFF</b>	Select to deactivate the Virtual Surround Back.
<b>V SB : ON</b>	While you play Dolby Digital EX software or DTS-ES software, the VIRTUAL SB (Surround Back) indicator lights up.

**Initial setting:** V SB : OFF

### NOTES

- When "SURREND SPK" is set to "NO" (see page 16), this function is not available.
- While playing back DTS-ES Matrix software with DTS 96/24, DTS 96/24 processing will not be performed with the Virtual Surround Back activated. To apply the processing, deactivate the Virtual Surround Back.
- Virtual Surround Back may not be applied to some software.

## Selecting the main or sub channel—DUAL MONO

You can select the playback sound (channel) you want while playing digital software recorded (or broadcast) in Dual Mono mode (see page 30), which includes two monaural channels separately.

<b>D MONO: SUB</b>	Select to play back the sub-channel (Ch 2).* Signal indicator "R" lights up while playing back this channel.
<b>D MONO:MAIN</b>	Select to play back the main channel (Ch 1).* Signal indicator "L" lights up while playing back this channel.
<b>D MONO: ALL</b>	Select to play back both the main and sub-channels (Ch 1/Ch 2).* Signal indicators "L" and "R" light up while playing back these channels.

**Initial setting:** D MONO:MAIN

\* Dual Mono signals can be heard from the following speakers—L (left front speaker), R (right front speaker), and C (center speaker), with respect to the current Surround setting:

Dual Mono setting	Without Surround		With Surround Activated				
			Center speaker setting				
			SML/LRG			NO	
L	R	L	C	R	L	R	
<b>SUB</b>	Ch 2	Ch 2	—	Ch 2	—	Ch 2	Ch 2
<b>MAIN</b>	Ch 1	Ch 1	—	Ch 1	—	Ch 1	Ch 1
<b>ALL</b>	Ch 1	Ch 2	—	Ch 1+Ch 2	—	Ch 1+Ch 2	Ch 1+Ch 2

### NOTE

The Dual Mono format is not identical with bilingual broadcasting for TV programs. So this setting does not take effect while watching such bilingual programs.

## Using the Midnight mode—MIDNIGHT M.

You can enjoy a powerful sound at night using the Midnight mode.

<b>NIGHT :OFF</b>	Select when you want to enjoy surround with its full dynamic range. (No effect applied.)
<b>NIGHT : 1</b>	Select when you want to reduce the dynamic range a little.
<b>NIGHT : 2</b>	Select when you want to apply the compression effect fully (useful at night).

**Initial setting:** NIGHT :OFF

### From the remote control:

Press **SOUND**, then **MIDNIGHT** repeatedly to select either one of above.

### NOTE

After pressing **SOUND**, the numeric buttons work for sound adjustments. To use the numeric buttons to operate your target source, press the corresponding source selecting button before operation; otherwise, the remote control may not work as you intend.

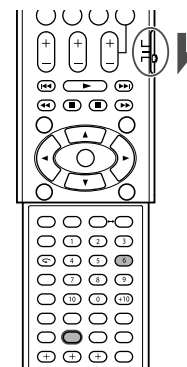

## Setting the digital input (DIGITAL IN) terminals—DIGITAL IN1/2

When you use the digital input terminals, register what components are connected to which terminals—DIGITAL IN1/2 (see page 9) so that the correct source name will appear when you select the digital source.

For **DIGITAL IN 1(DVR/DVD)** terminal:

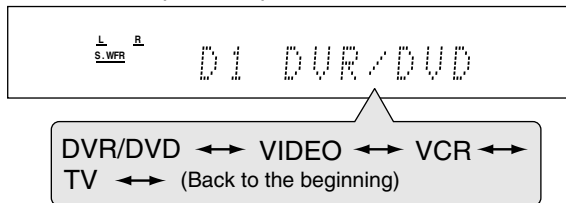

For **DIGITAL IN 2(VIDEO)** terminal:

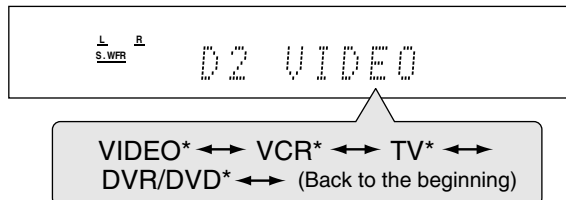

\* The one selected for “DIGITAL IN1” will be skipped.

<b>DVR/DVD</b>	For DVD player (or DVD recorder).
<b>VIDEO</b>	For the component connected to the VIDEO IN jack on the rear of the receiver.
<b>VCR</b>	For VCR.
<b>TV</b>	For TV.

**Initial setting:** DVR/DVD (for “DIGITAL IN1”)  
VIDEO (for “DIGITAL IN2”)

## Setting Auto Surround—AUTO SURRND

You can enjoy the Surround mode simply by selecting the source (with digital input selected for that source).

- Auto Surround also works when the input mode changes from analogue to digital.
- For details about the Surround/DSP modes, see pages 29 to 31. Select “AUTO SR: ON” when activating Auto Surround.

### AUTO SR: ON

- The AUTO SR indicator lights up on the display.
- If a multi-channel signal comes in, an appropriate Surround mode will be turned on.
  - If a Dolby Digital 2-channel or DTS 2-channel signal with surround signal comes in, “PLII MOVIE” will be selected.
  - If a Dolby Digital 2-channel or DTS 2-channel signal without surround signal comes in, “SURRND OFF (stereo)” will be selected.
  - If a Linear PCM signal comes in, nothing will change.

### AUTO SR:OFF

Select to deactivate Auto Surround.

**Initial setting:** AUTO SR:OFF

### NOTES

- This function does not take effect in the following cases:
  - While playing an analogue source,
  - While selecting any of DSP modes (see page 31), or one of the fixed digital decode mode—“DGTL D.D.” or “DGTL DTS” (see page 11), and
  - While listening with the headphones.
- If you press SURROUND with Auto Surround activated, Auto Surround will be canceled temporarily for the currently selected source.
  - Auto Surround setting will be restored in the following cases:
    - When you turn the receiver off and on,
    - When you change the source,
    - When you change the analogue/digital input, and
    - When you select “AUTO SR: ON” again.

## Setting the Auto Function mode —AUTO MODE

The source will be selected automatically simply by turning on a video component.

- This function takes effect for the video components connected to the receiver using the SCART cable—DVR/DVD and VCR.

### Auto Function mode works as follows:

- When a video component is turned on, the receiver selects the video component as the source (and the TV input is changed automatically).
- When a video component currently selected as the source is turned off, the receiver changes the source to the video source previously selected—DVR/DVD, VCR, or VIDEO.

<b>MODE: AUTO1</b>	Auto Function mode works when the receiver is turned on or when TV Direct is activated.
<b>MODE: AUTO2</b>	Auto Function mode works when the receiver is turned on or off, or when TV Direct is activated. (When a video component is turned on while the receiver is off, TV Direct is activated and the receiver selects the video component as the source.)

**MODE:MANUAL** You need to select the source manually.

### Initial setting: MODE:MANUAL

When “MODE: AUTO1” or “MODE: AUTO2” is selected, the AUTO MODE indicator lights up on the display.

### NOTES

- When selecting VCR as the source, “MODE: AUTO1” or “MODE: AUTO2” may not work if you only turn on the VCR. If this happens, you may need to start playback to activate Auto Function mode.
- When Auto Function mode is set to “MODE: AUTO2,” the TV Direct may be activated after recovery from a power failure.

# Sound adjustments

You can make sound adjustment to your preference after completing basic setting.

## Basic adjustment items

You can adjust the following items. See pages in parentheses for details.

- You cannot select the items which is not available with the current setting.

Items	To do
SUBWFR LVL	Adjust the subwoofer output level. (21)
FRONT L LVL*	Adjust the left front speaker output level. (21)
FRONT R LVL*	Adjust the right front speaker output level. (21)
CENTER LVL*	Adjust the center speaker output level. (21)
SURR L LVL*	Adjust the left surround speaker output level. (21)
SURR R LVL*	Adjust the right surround speaker output level. (21)
EFFECT	Adjust the effect level. (21)
PANORAMA	Add "wraparound" sound effect with side-wall image. (21)
BASS BOOST	Boost the bass level. (22)
INPUT ATT	Attenuate the input level of analogue source. (22)
CENTER TONE	Make the center tone soft or sharp. (21)
D EQ 63Hz	Adjust the equalization pattern of each band. (22)
D EQ 250Hz	
D EQ 1kHz	
D EQ 4kHz	
D EQ 16kHz	
SBWFR PHASE	Select the subwoofer sound phase. (22)

\* If you have used Smart Surround Setup on page 14, these settings are not required.

You can also use the remote control for sound adjustment except for "PANORAMA," "INPUT ATT," and "SBWFR PHASE."

## Operating procedure

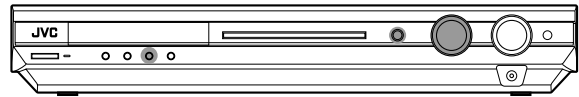

### On the front panel:

#### Before you start, remember...

There is a time limit in doing the following steps. If the setting is canceled before you finish, start from step 1 again.

Ex.: When adjusting subwoofer output level.

#### 1 Press ADJUST.

MULTI JOG now works for the sound adjustment.

#### 2 Turn MULTI JOG until the item you want to adjust appears on the display.

- As you turn MULTI JOG, the adjustment items change as follows:

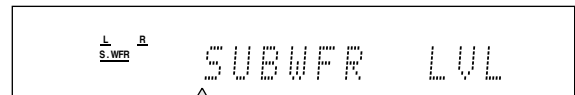

SUBWFR LVL	↔	FRONT L LVL	↔
FRONT R LVL	↔	CENTER LVL	↔
SURR L LVL	↔	SURR R LVL	↔
EFFECT	↔	PANORAMA	↔
BASS BOOST	↔	INPUT ATT	↔
CENTER TONE	↔	D EQ 63Hz	↔
D EQ 250Hz	↔	D EQ 1kHz	↔
D EQ 4kHz	↔	D EQ 16kHz	↔
SBWFR PHASE	↔	(Back to the beginning)	

#### 3 Press SET.

The current setting for the selected item appears.

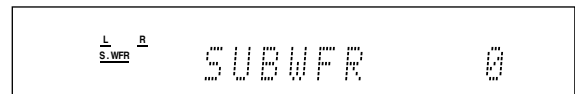

#### 4 Turn MULTI JOG to adjust the selected item.

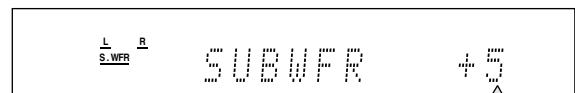

-10 ←-----→ 0 ←-----→ +10

Your adjustment is stored.

#### 5 Press SET.

#### 6 Repeat steps 2 to 5 to adjust other items if necessary.



## Adjusting speaker output level

- SUBWFR LVL (subwoofer output level),
- FRONT L LVL (left front speaker output level),
- FRONT R LVL (right front speaker output level),
- CENTER LVL (center speaker output level),
- SURR L LVL (left surround speaker output level),
- SURR R LVL (right surround speaker output level)

You can adjust the speaker output levels.

Adjust all the speakers' output levels so that you can listen sounds from all speakers at the same level.

- Once you have made an adjustment, it is memorized for each source.

**Adjustable range:** -10 (dB) to +10 (dB) (in 1 step intervals)

**Initial setting:** 0 (dB) for all speakers

### NOTES

- If you have selected "NO" for a speaker (see page 16), the output level for the corresponding speaker is not adjustable.
- While using headphones, you can adjust only the left and right front speakers' output level.
- If you change one of these settings (except the subwoofer output level) manually, the distance and output levels set by Smart Surround Setup will be cleared and those manually set will be effective.

### From the remote control:

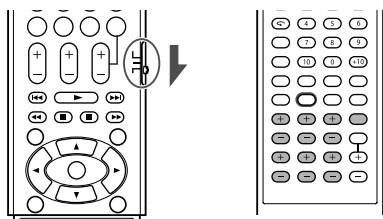

#### 1 Press TEST TONE to check the speakers' output balance.

"TEST L" starts flashing on the display, and a test tone comes out of the speakers in the following order:

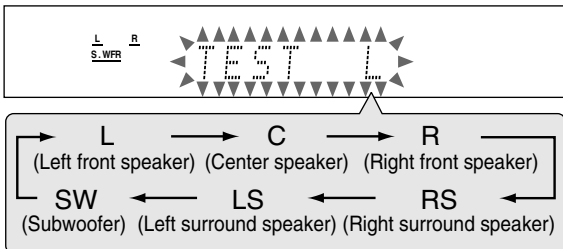

#### 2 Adjust the speaker output levels.

**To adjust the left front speaker level,**  
press FRONT L +/-.

**To adjust the right front speaker level,**  
press FRONT R +/-.

**To adjust the center speaker level,**  
press CENTER +/-.

**To adjust the left surround speaker level,**  
press SURR L +/-.

**To adjust the right surround speaker level,**  
press SURR R +/-.

**To adjust the subwoofer level,**  
press SUBWFR +/-.

#### 3 Press TEST TONE again to stop the test tone.

### NOTES

- You can adjust the speaker output levels without the test tone.
- No test tone is available when the HEADPHONE (or 3D HEADPHONE) mode is in use.

## Adjusting the sound parameters for the Surround/DSP modes

You can adjust the Surround/DSP sound parameters to your preference.

- For details about the Surround/DSP modes, see pages 29 to 33.

### Adjusting the effect level for DSP modes—EFFECT

This setting is available only when one of the DSP modes (except ALL CH ST.) is in use. To activate DSP mode, see pages 32 and 33.

- Once you have made an adjustment, it is memorized for each DSP mode.

**Adjustable range:** 1 to 5 (in 1 step intervals)

**Initial setting:** EFFECT 3

As the number increases, the effect becomes stronger. Normally, select "3."

### Adjusting the panorama control for Pro Logic II Music—PANORAMA

This setting is available only when Pro Logic II Music is in use. To activate Pro Logic II Music, see pages 32 and 33.

- Once you have made an adjustment, it is memorized until you change the setting.
- You cannot use the remote control for this setting.

**PANORAMA ON** Select to add "wraparound" sound effect with side-wall image.

**PANORAMA OFF** Select to listen to originally recorded sound.

**Initial setting:** PANORAMA OFF

### Adjusting the center tone—CENTER TONE

This setting is available when one of the Surround/DSP modes is in use.

- If you have set "CENTER SPK" to "NO" (see page 16), the center tone is not adjustable.
- This setting is common to all Surround modes, and is memorized separately for DSP modes.

**Adjustable range:** 1 to 5 (in 1 step intervals)

**Initial setting:** CNT TONE 3

As the number increases, the dialogue becomes stronger. Normally, select "3."

- When the center tone is set to other than "CNT TONE 3," the C.TONE indicator lights up on the display.

### From the remote control:

#### To adjust the effect level:

Press SOUND, then press EFFECT repeatedly.

#### To adjust the center tone:

Press SOUND, then press C.TONE repeatedly.

### NOTE

After pressing SOUND, the numeric buttons work for sound adjustments. To use the numeric buttons to operate your target source, press the corresponding source selecting button before operation; otherwise, the remote control may not work as you intend.

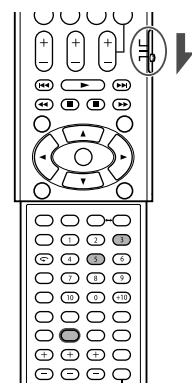

## Adjusting the bass sounds

### Reinforcing the bass—BASS BOOST

You can boost the bass level—Bass Boost.

- Once you have made an adjustment, it is memorized for each source.

**B.BOOST ON** Select to boost the bass level.  
The BASS indicator lights up on the display.

**B.BOOST OFF** Select to deactivate the Bass Boost.

**Initial setting:** B.BOOST OFF

**NOTE**

This function affects only the sound coming out through the front speakers.

**From the remote control:**

Press **SOUND**, then press **BASS BOOST** repeatedly.

- Each time you press BASS BOOST, the Bass Boost turns on and off alternately.

**NOTE**

After pressing SOUND, the numeric buttons work for sound adjustments. To use the numeric buttons to operate your target source, press the corresponding source selecting button before operation; otherwise, the remote control may not work as you intend.

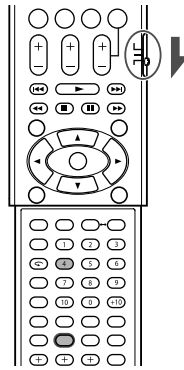

### Attenuating the input signal—INPUT ATT

When the input level of **analogue source** is too high, the sound will be distorted. If this happens, you need to attenuate the input signal level to prevent the sound distortion.

- Once you have made an adjustment, it is memorized for each source.
- You cannot use the remote control for this setting.

**ATT ON** Select to attenuate the input signal level.  
The ATT indicator lights up on the display.

**ATT NORMAL** Select to deactivate attenuation.

**Initial setting:** ATT NORMAL

### Selecting the subwoofer sound phase—SUBWFR PHASE

You can change the subwoofer sound phase to your preference.

- Once you have made an adjustment, it is memorized for each source.
- You cannot use the remote control for this setting.

**PHASE NORM.** Normally select this.

**PHASE REV.** Select this when you feel the bass sound is better with this mode rather than with “PHASE NORM.”

**Initial setting:** PHASE NORM.

**NOTE**

This function takes effect only when “SUBWOOFER” is set to “SUBWFR :YES” (see page 16).

### Adjusting the equalization patterns—D EQ 63Hz/250Hz/1kHz/4kHz/16kHz

You can adjust equalization patterns in five frequency bands (center frequency: 63 Hz, 250 Hz, 1 kHz, 4 kHz, 16 kHz) for the front speakers.

- Once you have made an adjustment, it is memorized for each source.

**Adjustable range:** –8 (dB) to +8 (dB) (in 2 dB intervals)

**Initial setting:** 0 (dB) for all bands

- When adjustment is made, the EQ indicator lights up on the display.

**To flatten the equalization pattern,** set all the frequency bands to “0 (dB).”

- The EQ indicator goes off from the display.

**From the remote control:**

- 1 Press D.EQ FREQ repeatedly to select the band you want to adjust.**
- 2 Press D.EQ LEVEL +/- to adjust the equalization pattern of the selected band.**

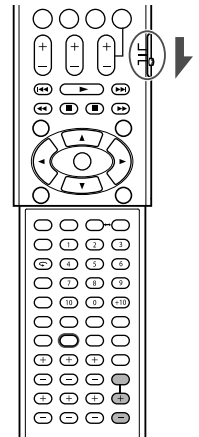

# Tuner operations

Tuner operations are mainly done from the remote control.

When you have selected "FM" or "AM" by using SOURCE SELECTOR on the front panel, press FM/AM on the remote control to use the remote control for tuner operations.

When operating the receiver using the remote control, set the mode selector to "AUDIO/TV/VCR/STB."

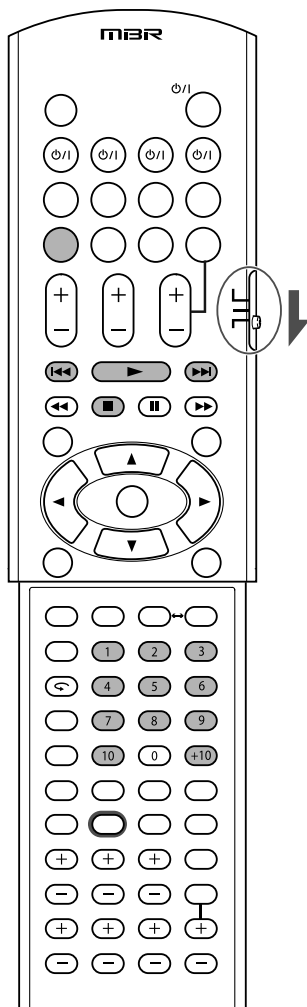

## Tuning in to stations manually

From the remote control **ONLY**:

### 1 Press FM/AM to select the band.

The last received station of the selected band is tuned in.

- Each time you press the button, the band alternates between FM and AM (MW).

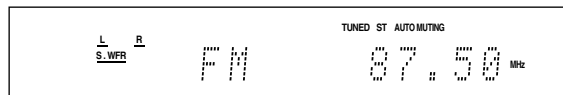

### 2 Press repeatedly or hold TUNING $\oplus$ or $\ominus$ TUNING until the station you want is tuned in.

- Pressing (or holding) TUNING  $\oplus$  increases the frequency.
- Pressing (or holding) TUNING  $\ominus$  decreases the frequency.

#### NOTES

- When you hold and release TUNING  $\oplus$  or TUNING  $\ominus$ , the frequency keeps changing until a station is tuned in.
- When a station of sufficient signal strength is tuned in, the TUNED indicator lights up on the display.
- When an FM stereo program is received, the ST (stereo) indicator also lights up.

## Using preset tuning

Once a station is assigned a channel number, the station can be quickly tuned simply by selecting the number. You can preset up to 30 FM and 15 AM (MW) stations.

### To store the preset stations

Before you start, remember...

There is a time limit in doing the following steps. If the setting is canceled before you finish, start from step 2 again.

From the remote control **ONLY**:

### 1 Tune in to the station you want to preset (see "Tuning in to stations manually" above).

- If you want to store the FM reception mode for this station, select the FM reception mode you want. See "Selecting the FM reception mode" on page 24.

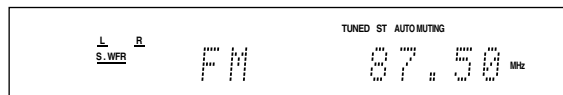

### 2 Press MEMORY.

The channel number position starts flashing on the display for about 5 seconds.

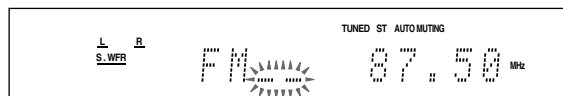

**3 Press the numeric buttons (1 – 10, +10) to select a channel number while the channel number position is flashing.**

- For channel number 5, press 5.
- For channel number 15, press +10, then 5.
- For channel number 30, press +10, +10, then 10.



**4 Press MEMORY again while the selected channel number is flashing on the display.**

The selected channel number stops flashing.  
The station is assigned to the selected channel number.

**5 Repeat steps 1 to 4 until you store all the stations you want.**

**To erase a stored preset station**

Storing a new station on a used channel number erases the previously stored one.

**To tune in a preset station**

**From the remote control:**

**1 Press FM/AM to select the band.**

The last received station of the selected band is tuned in and the numeric buttons now work for tuner operations.

- Each time you press the button, the band alternates between FM and AM (MW).

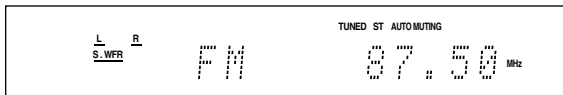

**2 Press the numeric buttons (1 – 10, +10) to select a preset channel number.**

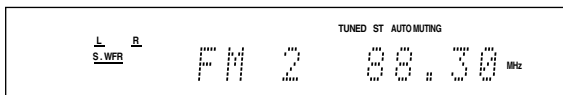

- For channel number 5, press 5.
- For channel number 15, press +10, then 5.
- For channel number 30, press +10, +10, then 10.

**On the front panel:**



**Before you start, remember...**

There is a time limit in doing the following steps. If the setting is canceled before you finish, start from step 2 again.

**1 Turn SOURCE SELECTOR to select “FM” or “AM.”**

The last received station of the selected band is tuned in.

**2 Press TUNER PRESET.**

“P” appears on the display and MULTI JOG now works for selecting preset channels.

**3 Turn MULTI JOG to select a preset channel number while “P” appears on the display.**

- To increase the preset channel numbers, turn MULTI JOG clockwise.
- To decrease the preset channel numbers, turn MULTI JOG counterclockwise.

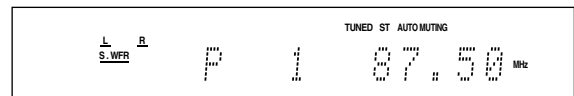

**Selecting the FM reception mode**

When an FM stereo broadcast is hard to receive or noisy, you can change the FM reception mode while receiving an FM broadcast.

- You can store the FM reception mode for each preset station (see page 23).

**From the remote control ONLY:**

**While listening to an FM station, press FM MODE.**

- Each time you press the button, the FM reception mode alternates between “AUTO MUTING” and “MONO.”

**AUTO MUTING:**

Normally select this.

When a program is broadcast in stereo, you will hear stereo sound; when in monaural, you will hear monaural sound. This mode is also useful to suppress static noise between stations. The AUTO MUTING indicator lights up on the display.

**MONO:**

Select this to improve the reception (but stereo effect will be lost).

In this mode, you will hear noise while tuning in to the stations. The AUTO MUTING indicator goes off from the display. (The ST indicator also goes off.)

**Initial setting:** AUTO MUTING

# Using the Radio Data System (RDS) to receive FM stations

Only the buttons on the remote control are used for RDS operations.

When operating the receiver using the remote control, set the mode selector to "AUDIO/TV/VCR/STB."

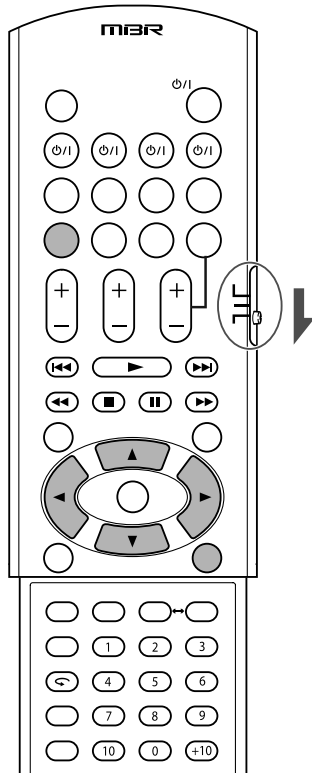

RDS allows FM stations to send an additional signal along with their regular program signals. For example, the stations send their station names, as well as information about what type of program they broadcast, such as sports or music, etc.

When an FM station which provides the RDS service is tuned in, the RDS indicator lights up on the display.

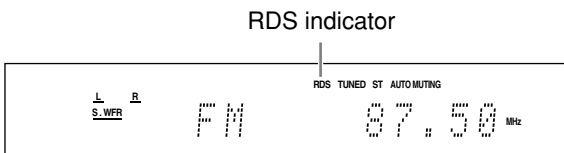

With the receiver, you can receive the following types of RDS signals:

<b>PS (Program Service):</b>	Shows commonly known station names.
<b>PTY (Program Type):</b>	Shows types of broadcast programs.
<b>RT (Radio Text):</b>	Shows text messages the station sends.
<b>Enhanced Other Networks:</b>	See page 28.

### NOTES

- RDS is not available for AM (MW) broadcasts.
- RDS may not operate correctly if the station tuned is not transmitting RDS signal properly or if the signal strength is weak.

### What information can RDS signals provide?

You can see the RDS signals the station sends on the display.

### Press DISPLAY while listening to an FM station.

- Each time you press the button, the display changes to show the following information:

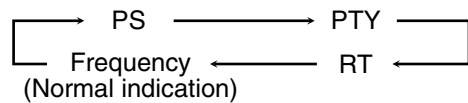

### PS (Program Service):

While searching, "PS" appears and then the station names will be displayed. "NO PS" appears if no signal is sent.

### PTY (Program Type):

While searching, "PTY" appears and then the type of the broadcast program will be displayed. "NO PTY" appears if no signal is sent.

### RT (Radio Text):

While searching, "RT" appears and then text messages the station sends will be displayed. "NO RT" appears if no signal is sent.

### Frequency:

Station frequency (non-RDS service).

### About characters shown on the display

When the display shows PS, PTY, or RT signals, the following characters are used:

- The display cannot show accented letters, "A" for instance, may stand for accented "A's" like "Á, Ä, Å, À, Â, â, ã, ä, à, and â."

### NOTE

If searching finishes at once, "PS," "PTY," and "RT" will not appear on the display.

## Searching for a program by PTY codes

One of the advantages of the RDS service is that you can locate a particular kind of program from the preset channels (see pages 23 and 24) by specifying the PTY codes.

### To search for a program using the PTY codes

#### Before you start, remember...

- To stop searching any time, press PTY SEARCH while searching.
- There is a time limit in doing the following steps. If the setting is canceled before you finish, start from step 1 again.

#### 1 Press PTY SEARCH while listening to an FM station.

"PTY SELECT" flashes on the display.

#### 2 While "PTY SELECT" is flashing, press PTY or PTY until the PTY code you want appears on the display.

#### 3 Press PTY SEARCH again while the PTY code selected in the previous step is still on the display.

While searching, "SEARCH" and the selected PTY code alternatively appears on the display.

The receiver searches 30 preset FM stations, stops when it finds the one you have selected, and tunes in to that station.

- If no program is found, "NOT FOUND" appears on the display.

#### To continue searching after the first stop

Press PTY SEARCH again while the indications on the display are flashing.

### PTY codes



- For details about each code, see "Description of the PTY codes" on page 27.

## Description of the PTY codes:

<b>News:</b>	News.
<b>Affairs:</b>	Topical program expanding or enlarging upon the news—debate or analysis.
<b>Info (Information):</b>	Programs the purpose of which is to impart advice in the widest sense.
<b>Sport:</b>	Programs concerned with any aspect of sports.
<b>Educate (Education):</b>	Educational programs.
<b>Drama:</b>	All radio plays and serials.
<b>Culture:</b>	Programs concerning any aspect of national or regional culture, including language, theatre, etc.
<b>Science:</b>	Programs about natural sciences and technology.
<b>Varied:</b>	Used for mainly speech-based programs such as quizzes, panel games and personality interviews.
<b>Pop M (Music):</b>	Commercial music of current popular appeal.
<b>Rock M (Music):</b>	Rock music.
<b>Easy M (Music):</b>	Current contemporary music considered to be “easy-listening.”
<b>Light M (Music):</b>	Instrumental music, and vocal or choral works.
<b>Classics:</b>	Performances of major orchestral works, symphonies, chamber music, etc.
<b>Other M (Music):</b>	Music not fitting into any of the other categories.
<b>Weather:</b>	Weather reports and forecasts.
<b>Finance:</b>	Stock Market reports, commerce, trading, etc.
<b>Children:</b>	Programs targeted at a young audience.

<b>Social:</b>	Programs about sociology, history, geography, psychology and society.
<b>Religion:</b>	Religious programs.
<b>Phone In:</b>	Involving members of the public expressing their views either by phone or at a public forum.
<b>Travel:</b>	Travel information.
<b>Leisure:</b>	Programs about recreational activities.
<b>Jazz:</b>	Jazz music.
<b>Country:</b>	Songs which originate from, or continue the musical tradition of the American Southern States.
<b>Nation M (Music):</b>	Current popular music of the nation or region in that country’s language.
<b>Oldies:</b>	Music from the so-called “golden age” of popular music.
<b>Folk M (Music):</b>	Music which has its roots in the musical culture of a particular nation.
<b>Document:</b>	Programs concerning factual matters, presented in an investigative style.
<b>TEST:</b>	Broadcasts for testing emergency broadcast equipment or unit.
<b>Alarm !:</b>	Emergency announcement.
<b>None:</b>	No program type, unidentified program, or difficult to categorize into particular types.

Classification of the PTY codes for some FM stations may be different from the above list.

## Switching to broadcast program of your choice temporarily

Another convenient RDS service is called “Enhanced Other Networks.”

This allows the receiver to switch temporarily to a broadcast program of your choice (TA, NEWS, and/or INFO) from a different station except in the following case:

- The Enhanced Other Networks mode only works when receiving an FM station with the Enhanced Other Networks code.

### Before you start, remember...

The Enhanced Other Networks function is only applicable to preset FM stations.

### Press TA/NEWS/INFO repeatedly until the program type you want appears on the display.

- Each time you press the button, the program type(s) change, and the corresponding indicator(s) light up as follows:

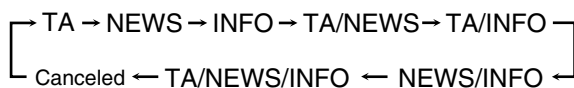

<b>TA:</b>	Traffic Announcement in your area.
<b>NEWS:</b>	News.
<b>INFO:</b>	Program the purpose of which is to impart advice in the widest sense.

### How the Enhanced Other Networks function actually works:

#### If another FM station starts broadcasting the program type you have selected while you are listening to an FM station

The receiver automatically switches to the station. The indicator of the received program type starts flashing.



When the program is over, the receiver goes back to the station previously tuned in, but still remains in Enhanced Other Networks standby mode. The indicator of the received program type stops flashing and remains lit.

#### If the station currently tuned in starts broadcasting the program type you have selected

The receiver continues to receive the station, but the indicator of the received program type starts flashing.



When the program is over, the indicator of the received program type stops flashing and remains lit, but the receiver remains in Enhanced Other Networks standby mode.

### To stop listening to the program selected by Enhanced Other Networks

Press TA/NEWS/INFO repeatedly again so that the program type (TA/NEWS/INFO) indicator goes off from the display. The receiver exits from Enhanced Other Networks standby mode and goes back to the previously selected station.

### When an emergency broadcast (Alarm ! signal) is sent from an FM station

The receiver automatically tunes in to the station except in the following cases:

- When you are listening to non-RDS Networks—all AM (MW) stations, some FM stations and other sources.
- When the receiver is in standby mode or TV Direct mode.

While receiving an emergency broadcast, “Alarm !” appears on the display.

### The TEST signal is used for equipment test—whether it can receive the Alarm ! signal correctly

The TEST signal makes the receiver work in the same way as the Alarm ! signal does. If the TEST signal is received, the receiver automatically switches to the station broadcasting the TEST signal.

While receiving the TEST signal, “TEST” appears on the display.

### NOTES

- Enhanced Other Networks data sent from some stations may not be compatible with this receiver.
- Enhanced Other Networks does not function for some FM stations with RDS service.
- While listening to a program tuned in by the Enhanced Other Networks function, the station does not change even if another network station starts broadcasting a program of the same Enhanced Other Networks data.
- While listening to a program tuned in by the Enhanced Other Networks function, you can only use the TA/NEWS/INFO and DISPLAY.

### CAUTION:

If the stations alternate intermittently between the station tuned by the Enhanced Other Networks function and the currently tuned station, press TA/NEWS/INFO repeatedly to cancel the Enhanced Other Networks function.

If you do not press the button, the currently tuned station is received finally, and the indication of the Enhanced Other Networks data type flashing on the display disappears.



# Creating realistic sound fields

## Reproducing theatre ambience

In a movie theatre, many speakers are located on the walls to reproduce impressive multi-surround sound, reaching you from all directions.

With these many speakers, sound localization and sound movement can be expressed.

Surround/DSP modes built in this receiver can create almost the same Surround sound as you can feel in a real movie theatre.

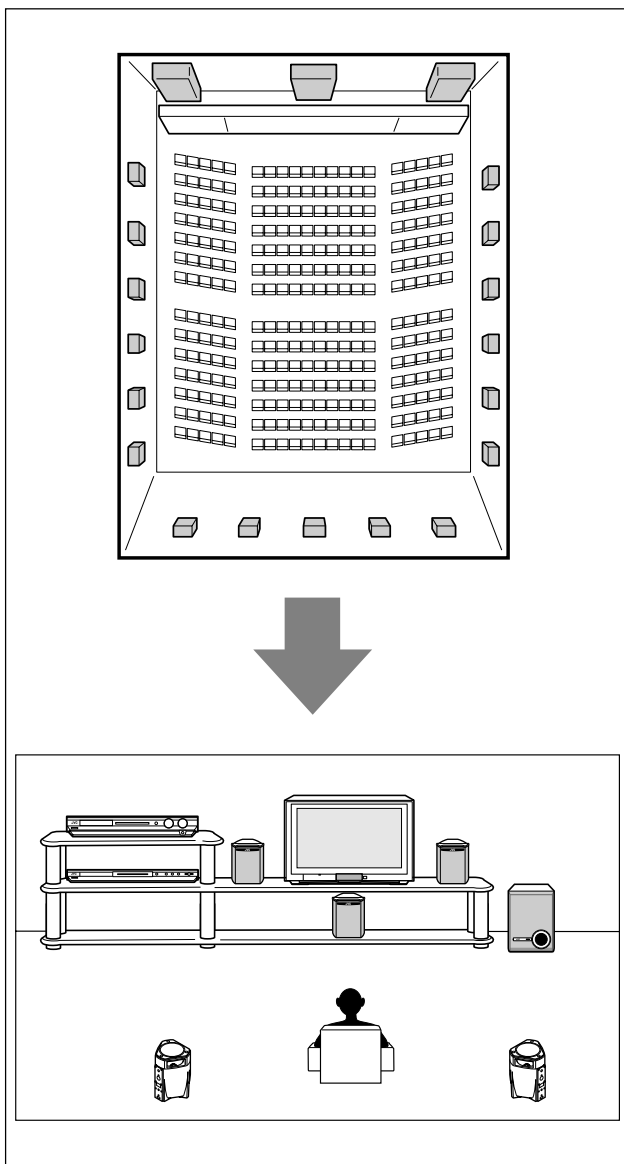

## Introducing the Surround modes

### ■ Dolby Digital\*

Dolby Digital is a digital signal compression method, developed by Dolby Laboratories, and enables multi-channel encoding and decoding (1ch up to 5.1ch).

- When Dolby Digital signal is detected through the digital input, the **DOLBY D** indicator lights up on the display.

### Dolby Digital 5.1CH

Dolby Digital 5.1CH (DOLBY D) encoding method records and digitally compresses the left front channel, right front channel, center channel, left surround channel, right surround channel, and LFE channel signals (total 6 channels, but the LFE channel is counted as 0.1 channel. Therefore, called 5.1 channel).

Dolby Digital enables stereo surround sounds, and sets the cutoff frequency of the surround treble at 20 kHz, compared to 7 kHz for Dolby Pro Logic. As such, the sound movement and “being-there” feeling are enhanced much more than Dolby Pro Logic.

Another digital surround encoding format introduced by Dolby Laboratories is **Dolby Digital EX**, which adds the third surround channels, called “surround back.”

Compared to the conventional Dolby Digital 5.1CH, these newly added surround back channels can reproduce more detailed movements behind you while viewing the video software. In addition, surround sound localization will become more stable.

- You can use Virtual Surround Back (see page 18) when playing back Dolby Digital EX software. This function creates the great surround effect from the behind as if you have connected the surround back speaker. The VIRTUAL SB indicator lights up on the display.

### Dolby Pro Logic II

Dolby Pro Logic II is a multi-channel playback format to convert 2-channel software into 5-channel (plus subwoofer). The matrix-based conversion method used for Dolby Pro Logic II makes no limitation for the cutoff frequency of the surround treble and enables stereo surround sound.

- This receiver provides two types of Dolby Pro Logic II modes—**Pro Logic II Movie** (PLII MOVIE) and **Pro Logic II Music** (PLII MUSIC).

When Dolby Pro Logic II is activated, the **PLII** indicator lights up on the display.

**PLII MOVIE:** Suitable for playing any Dolby Surround encoded software. You can enjoy a sound field very close to the one created with discrete 5.1-channel sounds.

**PLII MUSIC:** Suitable for playing any 2-channel stereo software. You can enjoy wide and deep sounds.

- To enjoy software encoded with Dolby Digital, connect the source component using the digital terminal on the rear of this receiver. (See page 9.)

\* Manufactured under license from Dolby Laboratories. “Dolby”, “Pro Logic”, and the double-D symbol are trademarks of Dolby Laboratories.

## ■ DTS\*\*

DTS is another digital signal compression method, developed by Digital Theater Systems, Inc., and enables multi-channel encoding and decoding (1ch up to 6.1ch).

- When DTS signal is detected through the digital input, the **DTS** indicator lights up on the display.

### DTS Digital Surround

DTS Digital Surround (DTS) is another discrete 5.1 channel digital audio format available on CD, LD, and DVD software.

Compared to Dolby Digital, the DTS Digital Surround format has a lower audio compression rate which enables it to add breadth and depth to the sounds reproduced. As such, DTS Digital Surround features natural, solid, and clear sound.

Another multi-channel digital surround encoding format introduced by Digital Theater Systems, Inc. is **DTS Extended Surround (DTS-ES)**.

It greatly improves the 360-degree surround impression and space expression by adding the third surround channel—surround back channel.

DTS-ES includes two signal formats with different surround signal recording methods—**DTS-ES Discrete 6.1ch** and **DTS-ES Matrix 6.1ch**.

- You can use the Virtual Surround Back (see page 18) when playing back DTS-ES software. This function creates the great surround effect from the behind as if you have connected the surround back speaker. The VIRTUAL SB indicator lights up on the display.

### DTS 96/24

In recent years, there has been increasing interest in higher sampling rates both for recording and for reproducing at home. Higher sampling rates allow wider frequency range and greater bit depths provide extended dynamic range.

DTS 96/24 is a multi-channel digital signal format (fs 96 kHz/24 bits) introduced by Digital Theater Systems, Inc. to deliver “better-than-CD sound quality” into the home.

- When DTS 96/24 signal is detected, the **DTS** and **96/24** indicators light up. You can enjoy its 5.1-channel sound with full-quality.

\*\*“DTS” and “DTS 96/24” are trademarks of Digital Theater Systems, Inc.

**When using Surround mode, the sounds come out of the activated speakers which the Surround mode requires.**

- **If either the surround speakers or center speaker is set to “NO” in the speaker setting (see page 16)**, the corresponding channel signals are allocated to and emitted through the front speakers.
- **If both the surround speakers and center speaker are set to “NO” in the speaker setting (see page 16)**, JVC’s original 3D-PHONIC processing (which has been developed to create the surround effect through the front speakers only) is used. The 3D indicator lights up on the display.

### 3D HEADPHONE mode

If you connect a pair of headphones while one of the Surround modes is in use, the 3D HEADPHONE mode is activated without respect to the type of software played back.

“3DHEADPHONE” appears on the display and the DSP, 3D, and HP indicators light up.

### About other digital signals

#### Linear PCM

Uncompressed digital audio data used for DVDs, CDs, and Video CDs.

DVDs support 2 channels with sampling rates of 48/96 kHz, at quantization of 16/20/24 bits. On the other hand, CDs and Video CDs are limited to 2 channels with 44.1 kHz at 16 bits.

- When Linear PCM signal is detected, the LPCM indicator lights up.

#### Dual Mono

Dual Mono can be easily understood when you think of the bilingual broadcast for TV programs (however, the Dual Mono format is not identical with those analogue formats).

This format is now adopted in Dolby Digital, DTS, and so on. It allows two independent channels (called main channel and sub-channel) to be recorded separately.

- You can select either channel you want to listen to (see page 18).

## Introducing the DSP modes

The sound heard in a concert hall, club, etc. consists of direct sound and indirect sound—early reflections and reflections from behind. Direct sounds reach the listener directly without any reflection. On the other hand, indirect sounds are delayed by the distances of the ceiling and walls. These direct sounds and indirect sounds are the most important elements of the acoustic surround effects.

The DSP modes can create these important elements, and give you a real “being there” feeling.

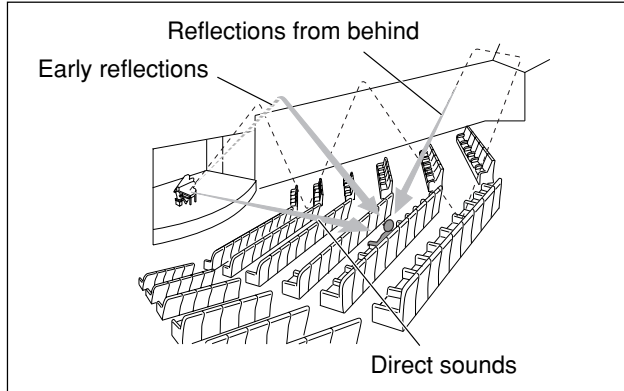

The DSP modes include the following modes:

- Digital Acoustic Processor (DAP) modes—HALL1, HALL2, LIVE CLUB, DANCE CLUB, PAVILION, THEATRE1, THEATRE2
- MONO FILM—Used for all types of 2-channel signals (including Dual Mono signal)
- All Channel Stereo mode (ALL CH ST.)

When one of the DSP modes is activated, the DSP indicator lights up on the display.

### ■ Digital Acoustic Processor (DAP) modes

You can use the following DAP modes in order to reproduce a more acoustic sound field in your listening room.

<b>HALL1</b>	Reproduces the spatial feeling of a large shoebox-shaped hall designed primarily for classical concerts. (Its seating capacity is about 2000.)
<b>HALL2</b>	Reproduces the spatial feeling of a large vineyard-shaped hall designed primarily for classical concerts. (Its seating capacity is about 2000.)
<b>LIVE CLUB</b>	Reproduces the spatial feeling of a live music club with a low ceiling.
<b>DANCE CLUB</b>	Reproduces the spatial feeling of a rocking dance club.
<b>PAVILION</b>	Reproduces the spatial feeling of an exhibition hall with a high ceiling.
<b>THEATRE1</b>	Reproduces the spatial feeling of a large theatre where the seating capacity is about 600.
<b>THEATRE2</b>	Reproduces the spatial feeling of a small theatre where the seating capacity is about 300.

#### NOTE

When “THEATRE1” or “THEATRE2” is activated while playing back 2-channel analogue or digital source, the built-in Dolby Pro Logic II decoder is activated and the indicator lights up.

When using the DAP mode, the sounds come out of all the connected and activated speakers.

- If the surround speakers are set to “NO” in the speaker setting (see page 16), JVC’s original 3D-PHONIC processing (which has been developed to create the surround effect through the front speakers only) is used. The 3D indicator lights up on the display.

### ■ MONO FILM

In order to reproduce a more acoustic sound field in your listening room while viewing monaural sound video software (analogue and 2-channel digital signals including Dual Mono signal), you can use this mode.

The surround effect will be added, and the sound localization of actor’s words will be improved.

**This mode cannot be used for multi-channel digital signals.**

When “MONO FILM” is used, sounds come out of all the connected (and activated) speakers.

- If the surround speakers are set to “NO” in the speaker setting (see page 16), JVC’s original 3D-PHONIC processing (which has been developed to create the surround effect through the front speakers only) is used. The 3D indicator lights up on the display.
- If incoming signals change from 2-channel digital signal to another digital signal type, “MONO FILM” is canceled and an appropriate Surround mode is activated.

### ■ All Channel Stereo mode (ALL CH ST.)

This mode can reproduce a larger stereo sound field using all the connected (and activated) speakers. **This mode cannot be used without activating the surround speakers.**

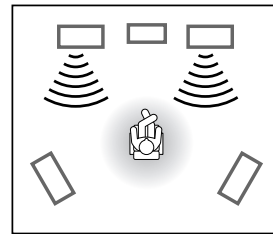

Sound reproduced from normal stereo

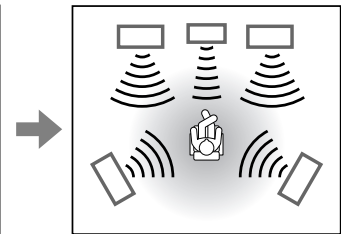

Sound reproduced from All Channel Stereo mode

### 3D HEADPHONE mode

If you connect a pair of headphones while one of the DSP modes is in use, the 3D HEADPHONE mode is activated without respect to the type of software played back. “3DHEADPHONE” appears on the display and the DSP, 3D, and HP indicators light up.

## Using the Surround/DSP modes

Available Surround/DSP modes vary depending on the incoming signal.  
For details, see "Available Surround and DSP modes according to the incoming signal" on page 33.

**Activating one of the Surround/DSP modes for a source automatically recalls the memorized settings and adjustments.**

- To adjust the speaker output level, see page 21.
- To adjust the effect level for the DSP mode (except All Channel Stereo mode), see page 21.
- To add "wraparound" sound effect to PLII MUSIC (PANORAMA control), see page 21.

### NOTE

You cannot select All Channel Stereo mode if the surround speakers are set to "NO" in the speaker setting (see page 16).

### If "AUTO SURRND (Auto Surround)" is set to "ON"

You can enjoy Surround mode simply by playing back multi-channel software (with digital input selected for that source).  
To activate Auto Surround, see page 19.

### From the remote control:

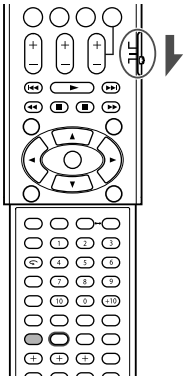

When operating the receiver using the remote control, set the mode selector to "AUDIO/TV/VCR/STB."

### 1 Select and play any source you like.

- Make sure you have selected the input mode (analogue or digital) correctly.

### 2 Press SURROUND repeatedly to select the Surround/DSP mode you want.

- For Dolby Digital multi-channel software (except 2-channel and Dual Mono software):

DOLBY D    L C R  
S.WFR    LFE  
LS    RS    **DOLBY D**

DOLBY D	→	HALL1	→
HALL2	→	LIVE CLUB	→
DANCE CLUB	→	PAVILION	→
THEATRE1	→	THEATRE2	→
ALL CH ST.	→	SURRND OFF	→

(Back to the beginning)

- For DTS multi-channel software (except 2-channel and Dual Mono software):

DTS    L C R  
S.WFR    LFE  
LS    RS    **DTS**

DTS	→	HALL1	→
HALL2	→	LIVE CLUB	→
DANCE CLUB	→	PAVILION	→
THEATRE1	→	THEATRE2	→
ALL CH ST.	→	SURRND OFF	→

(Back to the beginning)

- For Dual Mono software:

You can select the channel you listen to (see page 18).

DOLBY D    L  
S.WFR    R    **DUAL MONO**

DUAL MONO	→	HALL1	→
HALL2	→	LIVE CLUB	→
DANCE CLUB	→	PAVILION	→
THEATRE1	→	THEATRE2	→
MONO FILM	→	ALL CH ST.	→
SURRND OFF	→	(Back to the beginning)	

- For digital 2-channel software or analogue sources:

Ex.: When Linear PCM is coming in.

LPCM    L    R    DD PLII  
S.WFR    PLII MOVIE

PLII MOVIE	→	PLII MUSIC	→
HALL1	→	HALL2	→
LIVE CLUB	→	DANCE CLUB	→
PAVILION	→	THEATRE1	→
THEATRE2	→	MONO FILM	→
ALL CH ST.	→	SURRND OFF	→

(Back to the beginning)

### Virtual Surround Back

When playing **Dolby Digital EX** or **DTS-ES** software, you can enjoy surround back channel playback using the Virtual Surround Back.

Ex.: When playing back DTS-ES software.

VIRTUAL SB  
DTS    L C R  
S.WFR    LFE  
LS SB    RS    **DTS**

To activate the Virtual Surround Back, see page 18.

### To cancel Surround/DSP modes

Press SURROUND repeatedly so that "SURRND OFF" appears on the display.

## On the front panel:

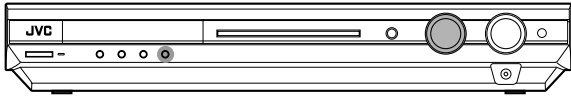

### Before you start, remember...

There is a time limit in doing the following steps. If the setting is canceled before you finish, start from step **2** again.

### 1 Select and play any source you like.

- Make sure you have selected the input mode (analogue or digital) correctly.

### 2 Press SURROUND.

### 3 Turn MULTI JOG to select the Surround/DSP mode you want.

- For Dolby Digital multi-channel software (except 2-channel and Dual Mono software):

DOLBY D

DOLBY D	↔	HALL1	↔	
HALL2	↔	LIVE CLUB	↔	
DANCE CLUB	↔	PAVILION	↔	
THEATRE1	↔	THEATRE2	↔	
ALL CH ST.	↔	SURRND OFF	↔	

(Back to the beginning)

- For DTS multi-channel software (except 2-channel and Dual Mono software):

DTS

DTS	↔	HALL1	↔	
HALL2	↔	LIVE CLUB	↔	
DANCE CLUB	↔	PAVILION	↔	
THEATRE1	↔	THEATRE2	↔	
ALL CH ST.	↔	SURRND OFF	↔	

(Back to the beginning)

- For Dual Mono software:

You can select the channel you listen to (see page 18).

DUAL MONO

DUAL MONO	↔	HALL1	↔	
HALL2	↔	LIVE CLUB	↔	
DANCE CLUB	↔	PAVILION	↔	
THEATRE1	↔	THEATRE2	↔	
MONO FILM	↔	ALL CH ST.	↔	
SURRND OFF	↔	(Back to the beginning)	↔	

- For digital 2-channel software or analogue sources:

Ex.: When Linear PCM is coming in.

PL II MOVIE

PLII MOVIE	↔	PLII MUSIC	↔	
HALL1	↔	HALL2	↔	
LIVE CLUB	↔	DANCE CLUB	↔	
PAVILION	↔	THEATRE1	↔	
THEATRE2	↔	MONO FILM	↔	
ALL CH ST.	↔	SURRND OFF	↔	

(Back to the beginning)

### Virtual Surround Back

When playing **Dolby Digital EX** or **DTS-ES** software, you can enjoy surround back channel playback using the Virtual Surround Back.

Ex.: When playing back DTS-ES software.

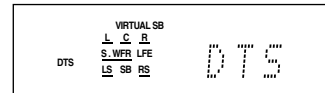

To activate the Virtual Surround Back, see page 18.

### To cancel Surround/DSP modes

Turn MULTI JOG so that "SURRND OFF" appears on the display.

## Available Surround and DSP modes according to the incoming signal

Modes Incoming signal	Surround modes	DSP modes	HEADPHONE mode	Surround/DSP off
Dolby Digital (multi-channel)	DOLBY D	HALL1/2, LIVE CLUB, DANCE CLUB, PAVILION, THEATRE1/2, ALL CH ST.*2	HEADPHONE, 3D HEADPHONE	SURRND OFF (stereo)
Dolby Digital EX	DOLBY D (Virtual Surround Back*1)			
DTS (multi-channel)	DTS	HALL1/2, LIVE CLUB, DANCE CLUB, PAVILION, THEATRE1/2, MONO FILM, ALL CH ST.*2	HEADPHONE, 3D HEADPHONE	SURRND OFF (stereo)
DTS-ES	DTS (Virtual Surround Back)			
Dual Mono	DUAL MONO	HALL1/2, LIVE CLUB, DANCE CLUB, PAVILION, THEATRE1/2, MONO FILM, ALL CH ST.*2	HEADPHONE, 3D HEADPHONE	SURRND OFF (stereo)
Dolby Digital (2-channel)	PLII MOVIE, PLII MUSIC			
DTS (2-channel)				
Linear PCM				
Analogue				

\*1 Virtual Surround Back may not be applied to some software.

\*2 Not selectable if the surround speakers are set to "NO" in the speaker setting (see page 16).

# Operating other JVC products

You can use the supplied remote control to operate not only the receiver/DVD player but also other JVC products.

- Refer also to the manuals supplied with the other products.
  - Some JVC VCRs can accept two types of the control signals—remote codes “A” and “B.” This remote control can operate a VCR whose remote control code is set to “A.”
  - Some JVC DVD recorders can accept four types of the control signals. This remote control can operate a DVD recorder whose remote control code is set to the initial code. For details, refer to the manual supplied with the DVD recorder.
- To operate other products, aim the remote control directly at the remote sensor on the target product.

## ■ TV

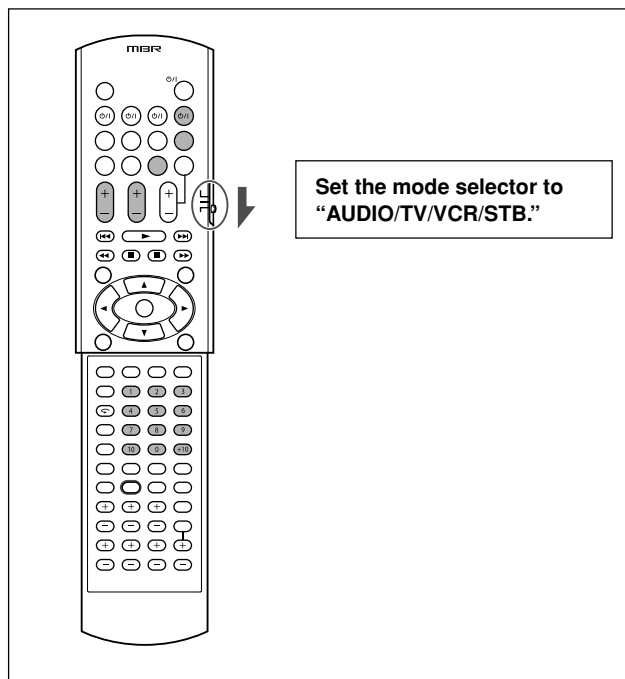

You can always perform the following operations:

<b>TV <math>\odot</math>/I:</b>	Turn on or off the TV.
<b>TV VOL +/-:</b>	Adjust the volume on the TV.
<b>TV/VIDEO:</b>	Change the input mode (either video input or TV tuner) on the TV.

After pressing TV, you can perform the following operations on the TV.

<b>CHANNEL +/-:</b>	Change the channel numbers.
<b>1 – 9, 0, 100+:</b>	Select the channel numbers.
<b>TV RETURN (10):</b>	Function as the TV RETURN button.

## ■ VCR

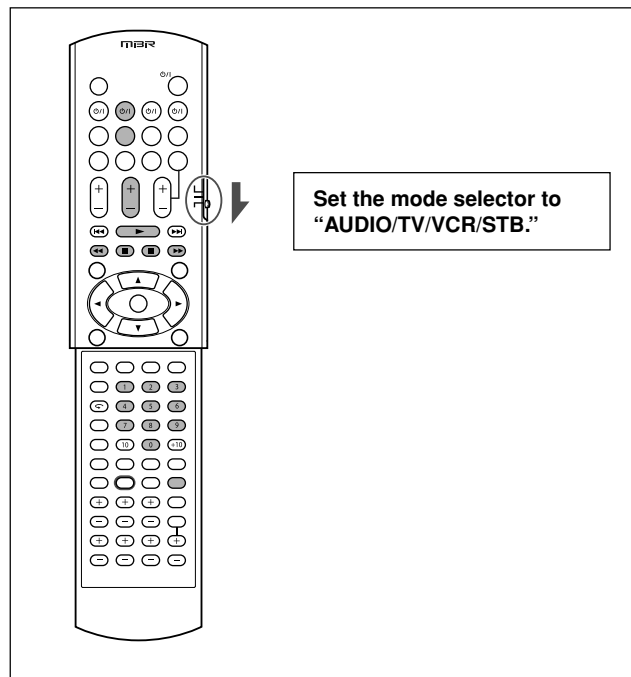

You can always perform the following operation:

<b>VCR <math>\odot</math>/I:</b>	Turn on or off the VCR.
----------------------------------	-------------------------

After pressing VCR, you can perform the following operations on the VCR.

<b>CHANNEL +/-:</b>	Change the channel numbers on the VCR.
<b>1 – 9, 0:</b>	Select the channel numbers on the VCR.
<b>▶:</b>	Start playback.
<b>■:</b>	Stop playback.
<b>  :</b>	Pause playback. To release it, press ▶.
<b>▶▶:</b>	Fast-wind a tape.
<b>◀◀:</b>	Rewind a tape.
<b>REC PAUSE:</b>	Enter recording pause. To start recording, press this button then ▶.

## ■ DVD recorder or DVD player

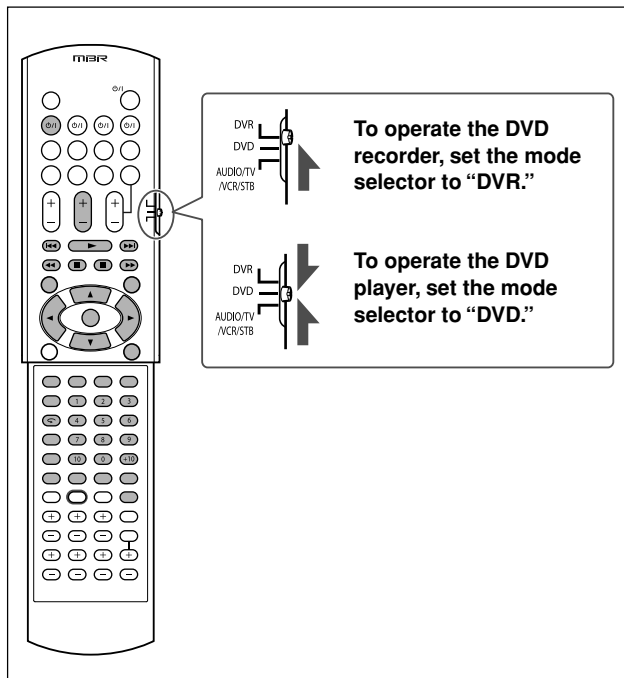

After setting the mode selector, you can perform the following operations on the DVD recorder or DVD player.

See the instructions supplied with the DVD recorder or DVD player for details.

**DVR/DVD** : Turn on or off the DVD recorder or DVD player.

**CHANNEL +/-** (for DVD recorder only):  
Change the channel numbers on the DVD recorder.

**▶**: Start playback.

**■**: Stop playback.

**||**: Pause playback. To release it, press **▶**.

**▶▶**: Skip to the beginning of the next chapter.

**◀◀**: Return to the beginning of the current (or previous) chapter.

**▶▶▶**: Fast-forward playback.

**◀◀◀**: Fast-reverse playback.

**TOP MENU/MENU**:  
Display the menu recorded on DVD VIDEO discs.

**ON SCREEN**: Shows the on-screen bar.

**▲/▼/▶/◀**: Select an item on the menu screen.

**ENTER**: Enter the selected item, channel number, or track number.

**1 – 9, 0** (for DVD recorder):  
Select channel numbers or track numbers. (Press ENTER to enter the number.)

**1 – 10, 0, +10** (for DVD player):  
Select a track number, menu item, etc.

You can also use the following buttons to operate JVC DVD recorder or DVD player if it supports the corresponding function:

### For various settings:

**AUDIO**: Select the audio language/channel.  
**SUBTITLE**: Select the subtitle language.  
**SET UP**: Display the Preference display.  
**VFP**: Adjust the picture.  
**PROGRESSIVE\***: Change the scanning mode.  
**ANGLE**: Select the view angle.

### For various playback:

**TITLE/GROUP**: Make the numeric buttons work for selecting the title/group number.  
**ZOOM** (for DVD player only): Zoom in and out.  
**◀** (one touch replay): Move the playback position back 10 seconds before the current position.  
**RETURN**: Return to the main menu during menu operation.  
**CANCEL**: Cancel the programmed track, etc.  
**SLIDE EFFECT\***: Select the effect for the slide show playback for JPEG discs.  
**SOUND EFFECT** (for DVD player only): Select the sound effect.

### For recording (for DVD recorder ONLY):

**REC PAUSE**: Enter recording pause. To release it, press **▶**.

### For other functions:

**DVD, HDD** (for DVD recorder incorporated with HDD deck):  
Select the DVD recorder or HDD deck.  
**DISPLAY**: Change the display information.  
**DIMMER\***: Change the display brightness.

### NOTES

- Press and hold when using the buttons marked with an asterisk (\*).
- If these buttons do not function normally, use the remote control supplied with your DVD recorder or DVD player. Refer also to the manuals supplied with the DVD recorder or DVD player for details.

# Operating other manufacturers' products

By changing the transmittable signals, you can use the supplied remote control to operate other manufacturers' products.

- Refer also to the manuals supplied with the other products.
- To operate those components with the remote control, first you need to set the manufacturers' codes each for the STB, VCR, and TV.
- After replacing batteries of the remote control, set the manufacturers' codes again.

## □ Changing the transmittable signals for operating a TV

Set the mode selector to "AUDIO/TV/VCR/STB."

**1 Press and hold TV  $\phi$ /I.**

**2 Press TV.**

**3 Enter the manufacturer's code using buttons 1 – 9, and 0.**

See "Manufacturers' codes for TV" on the right column.

**4 Release TV  $\phi$ /I.**

Now, you can perform the following operations on the TV.

TV $\phi$ /I:	Turn on or off the TV.
TV VOL +/-:	Adjust the volume on the TV.
TV/VIDEO:	Change the input mode (either TV or VIDEO).

After pressing TV, you can perform the following operations on the TV.

CHANNEL +/-:	Change the channel numbers.
1 – 9, 0, +10 (100+):	Select the channel numbers.

See the instructions supplied with the TV for details.

**5 Try to operate your TV by pressing TV  $\phi$ /I.**

When your TV turns on or off, you have entered the correct code.

If more than one code is listed for your brand of TV, try each one until the correct one is entered.

## Manufacturers' codes for TV

Manufacturer	Codes
JVC	01
Akai	02, 05
Blaupunkt	03
Daewoo	09, 30, 31
Fenner	04, 30, 31
Fisher	05
Grundig	06
Hitachi	07, 08
Irradio	02, 05
Magnavox	09
Mitsubishi	10, 32
Miver	03
Nokia	11, 33
Nordmende	12, 13, 17, 25, 26, 27
Orion	14
Panasonic	15, 16
Philips	09
Saba	12, 13, 17, 25, 26, 27
Samsung	09, 18, 31
Sanyo	05
Schneider	02, 05
Sharp	19
Sony	20, 21, 22, 23, 24
Telefunken	12, 13, 17, 25, 26, 27
Thomson	12, 13, 17, 25, 26, 27, 29
Toshiba	28

Initial setting: 01



❑ **Changing the transmittable signals for operating a VCR**

Set the mode selector to "AUDIO/TV/VCR/STB."

- 1 Press and hold VCR**  $\odot/\text{L}$ .
- 2 Press VCR.**
- 3 Enter the manufacturer's code using buttons 1 – 9, and 0.**

See "Manufacturers' codes for VCR" on right column.

**4 Release VCR**  $\odot/\text{L}$ .

Now, you can perform the following operation on the VCR.

<b>VCR</b> $\odot/\text{L}$ :	Turn on or off the VCR.
-------------------------------	-------------------------

After pressing VCR, you can perform the following operations on the VCR.

<b>CHANNEL +/-:</b>	Change the channel numbers on the VCR.
---------------------	--

<b>1 – 9, 0:</b>	Select the channel numbers on the VCR.
------------------	--

<b>▶:</b>	Start playback.
-----------	-----------------

<b>■:</b>	Stop playback.
-----------	----------------

<b>⏸:</b>	Pause playback.
-----------	-----------------

<b>▶▶:</b>	Fast-wind a tape.
------------	-------------------

<b>◀◀:</b>	Rewind a tape.
------------	----------------

See the instructions supplied with the VCR for details.

**5 Try to operate your VCR by pressing VCR**  $\odot/\text{L}$ .

When your VCR turns on or off, you have entered the correct code.

If more than one code is listed for your brand of VCR, try each one until the correct one is entered.

**Manufacturers' codes for VCR**

Manufacturer	Codes
JVC	01
Akai	02, 36
Bell+Howell	03, 16
Blaupunkt	04
CGM	03, 05, 16
Daewoo	34
Digital	05
Fisher	03, 16
GE	06
Grundig	07
Hitachi	08, 09
Loewe	05, 10, 11
Magnavox	04, 05
Mitsubishi	12, 13, 14, 15
Nokia	16
Nordmende	17, 18, 19, 31
Orion	20
Panasonic	21
Philips	05, 22
Phonola	05
Saba	17, 18, 19, 23, 31
Samsung	24, 25
Sanyo	03, 16
Sharp	26, 27
Siemens	07
Sony	28, 29, 30, 35
Telefunken	17, 18, 19, 31, 32
Toshiba	33

Initial setting: 01

Manufacturers' codes are subject to change without notice. If they are changed, this remote control cannot operate the equipment.

**❑ Changing the transmittable signals for operating an STB**

Set the mode selector to "AUDIO/TV/VCR/STB."

- 1 Press and hold STB**  $\odot/\text{I}$ .
- 2 Press STB CONTROL.**
- 3 Enter the manufacturer's code using buttons 1 – 9, and 0.**

See "Manufacturers' codes for STB" on the right column.

**4 Release STB**  $\odot/\text{I}$ .

Now, you can perform the following operation on the STB.

<b>STB</b> $\odot/\text{I}$ :	Turn on or off the STB.
-------------------------------	-------------------------

After pressing STB CONTROL, you can perform the following operations on the STB.

<b>CHANNEL +/-</b> :	Change the channel numbers on the STB.
----------------------	--

<b>1 – 9, 0</b> :	Select the channel numbers on the STB.
-------------------	--

See the instructions supplied with the STB for details.

**5 Try to operate your STB by pressing STB**  $\odot/\text{I}$ .

When your STB turns on or off, you have entered the correct code.

If more than one code is listed for your brand of STB, try each one until the correct one is entered.

**Manufacturers' codes for STB**

Manufacturer	Codes
JVC	01, 02
Amstrad	03, 04, 05, 06, 33
BT	01
Canal Stellite	22
Canal +	22
D-Box	26
Echostar	19, 20, 21, 23
Finlux	11
Force	30
Galaxis	29
Grundig	07, 08
Hirschmann	07, 19, 39
ITT Nokia	11
Jerrold	16
Kathrein	13, 14, 36
Luxor	11
Mascom	34
Maspro	13
Nokia	26, 28, 35
Pace	10, 27, 33
Panasonic	15
Philips	09, 25
RFT	12
Saba	37
Sagem	24, 31
Salora	11
Selector	31
Skymaster	12, 38
Thomson	37
TPS	24
Triax	32
Videoway	17, 18
Wisi	07

Initial setting: 01

Manufacturers' codes are subject to change without notice. If they are changed, this remote control cannot operate the equipment.

# Troubleshooting

Use this chart to help you solve daily operational problems. If there are any problems you cannot solve, contact your JVC's service center.

## Power

### The power does not come on.

- ➔ The power cord is not plugged in. Plug the power cord into an AC outlet.

### The receiver turns off (enters standby mode).

- ➔ Speakers are overloaded because of high volume.
  1. Stop the playback source.
  2. Turn on the receiver again, then turn the volume down.
- ➔ Speakers are overloaded because of a short circuit at the speaker terminals. Check the speaker wiring. If speaker wiring is not short-circuited, contact your dealer.
- ➔ The receiver is overloaded because of a high voltage. Consult your dealer after unplugging the power cord.

### "OVER HEAT" flashes on the display, then the receiver turns off.

- ➔ The receiver is overheated because of high volume or long time usage. Turn on the receiver again. If the receiver turns off soon, consult your dealer after unplugging the power cord.

## Sound

### No sound from speakers.

- ➔ Speaker signal cables are not connected. Check speaker wiring, then reconnect if necessary (see page 6) after unplugging the power cord.
- ➔ Connections are incorrect. Check the audio connections (see pages 7 to 9) after unplugging the power cord.
- ➔ An incorrect source is selected. Select the correct source.
- ➔ Muting is activated. Press MUTING to cancel the mute (see page 13).
- ➔ An incorrect input mode (analogue or digital) is selected. Select the correct input mode (analogue or digital).
- ➔ TV Direct is activated. Deactivate TV Direct (see page 12).

### Sound from one speaker only.

- ➔ Speaker signal cables are not connected properly. Check speaker wiring and reconnect if necessary (see page 6) after unplugging the power cord.

### Bass sound is reinforced too much when listening in stereo.

- ➔ Adjust audio position level (see page 12).

### Sounds are intermittently distorted by the outside noise such as a lightning discharge.

- ➔ When you use the digital coaxial connection, the sounds may be intermittently distorted by the outside noise such as a lightning discharge but the sound will be restored automatically. This is not a malfunction.

## Remote control

### Remote control does not operate as you intend.

- ➔ The remote control is not ready for your intended operation. Set the mode selector correctly, then press the corresponding source selecting button or SOUND before operation.

### Remote control does not work.

- ➔ There is an obstruction hiding the remote sensor on the receiver. Remove the obstruction.
- ➔ Batteries are weak. Replace batteries.
- ➔ The mode selector is set to the incorrect position. Set the mode selector to the proper position.

### Buttons cannot be used.

- ➔ TV Direct is activated. Deactivate TV Direct (see page 12).

## Tuner

### Continuous hiss or buzzing during FM reception.

- ➔ Incoming signal is too weak. Connect an outdoor FM antenna or contact your dealer.
- ➔ The station is too far away. Select another station.
- ➔ The wrong antenna is being used. Check with your dealer to be sure you have the correct antenna.
- ➔ Antennas are not connected properly. Check the connections.

### Occasional cracking noise during FM reception.

- ➔ Ignition noise from automobiles. Move the antenna farther from automobile traffic.

# Specifications

Designs and specifications are subject to change without notice.

## Amplifier

### Output Power

At stereo operation:

Front channels: 50 W per channel, min. RMS, both channels driven into 6  $\Omega$  at 1 kHz with no more than 10% total harmonic distortion. (IEC268-3)

At surround operation:

Front channels: 50 W per channel, min. RMS, driven into 6  $\Omega$  at 1 kHz with no more than 0.8% total harmonic distortion.

Center channel: 50 W, min. RMS, driven into 6  $\Omega$  at 1 kHz, with no more than 0.8% total harmonic distortion.

Surround channels: 50 W per channel, min. RMS, driven into 6  $\Omega$  at 1 kHz, with no more than 0.8% total harmonic distortion.

## Audio

Audio Input Sensitivity/Impedance:

DVR/DVD, VCR, TV, VIDEO: 170 mV(p-p)/47 k $\Omega$

Audio Input (DIGITAL IN)\*:

Coaxial: DIGITAL IN 1(DVR/DVD):  
0.5 V(p-p)/75  $\Omega$

Optical: DIGITAL IN 2(VIDEO): -21 dBm to -15 dBm  
(660 nm  $\pm$ 30 nm)

\* Corresponding to Linear PCM, Dolby Digital, and DTS Digital Surround (with sampling frequency—32 kHz, 44.1 kHz, 48 kHz).

Audio Output Level

DVR/DVD, VCR, TV: 170 mV

Signal-to-Noise Ratio ('66 IHF/DIN): 80 dB/62 dB

Frequency Response (6  $\Omega$ ): 20 Hz to 20 kHz ( $\pm$ 1 dB)

Bass Boost: +4 dB  $\pm$ 1 dB at 100 Hz

Equalization:

Center frequency: 63 Hz, 250 Hz, 1 kHz, 4 kHz, 16 kHz

Control range:  $\pm$ 8 dB

## Video

Video Input Sensitivity/Impedance:

Composite video: DVR/DVD, VCR, TV, VIDEO:  
1 V(p-p)/75  $\Omega$

S-video: DVR/DVD, VCR:

Y (luminance): 1 V(p-p)/75  $\Omega$

C (chrominance, burst): 0.3 V(p-p)/75  $\Omega$

RGB: DVR/DVD, VCR: 0.7 V(p-p)/75  $\Omega$

Component: DVR/DVD:

Y (luminance): 1 V(p-p)/75  $\Omega$

PB, PR: 0.7 V(p-p)/75  $\Omega$

Video Output Level/Impedance:

Composite video: DVR/DVD, VCR, TV:  
1 V(p-p)/75  $\Omega$

S-video: TV:

Y (luminance): 1 V(p-p)/75  $\Omega$

C (chrominance, burst): 0.3 V(p-p)/75  $\Omega$

RGB: TV: 0.7 V(p-p)/75  $\Omega$

Component: MONITOR OUT:

Y (luminance): 1 V(p-p)/75  $\Omega$

PB, PR: 0.7 V(p-p)/75  $\Omega$

Synchronization:

Negative

## FM tuner (IHF)

Tuning Range: 87.50 MHz to 108.00 MHz

Usable Sensitivity:

Monaural: 17.0 dBf (1.95  $\mu$ V/75  $\Omega$ )

50 dB Quieting Sensitivity:

Monaural: 21.3 dBf (3.2  $\mu$ V/75  $\Omega$ )

Stereo: 41.3 dBf (31.5  $\mu$ V/75  $\Omega$ )

Stereo Separation at Rec Out:

35 dB at 1 kHz

## AM (MW) tuner

Tuning Range: 522 kHz to 1 629 kHz

## General

Power Requirements: AC 230 V $\sim$ , 50 Hz

Power Consumption: 120 W (at operation)  
2 W (in standby mode)

Dimensions (W x H x D): 435 mm x 70 mm x 326.5 mm

Mass: 5.6 kg

RX-E55

HOME CINEMA CONTROL CENTER



EN